

# thermostaten

# 4

clixonthermostaten.....	210
per fabrikant.....	213
regelthermostaten met temperatuur weergave.....	273
thermostaten opbouw.....	274
ruimte thermostaten.....	275
staafthermostaten.....	275
koelingthermostaten.....	276
diversen.....	279
toebehoren.....	279



## thermostaten

## clixonthermostaten

## maximaal clixonthermostaten



afb.	bestelnr.	LA (mm)	T.uit (°C)	functie	SC (A)	aansluiting
1	9995.7821	-	68	1NC	16	F6,3
1	9451.1892	-	95	1NC	10	F6,3
1	9162.1970	-	110	1NC	16	F6,3
1	9451.1886	-	130	1NC	16	F6,3
1	9451.1897	-	175	1NC	16	F6,3
2	9995.7822	-	70	1NC	16	F6,3
3	9995.7822	-	100	NC	10	F6,3
3	9775.1180	-	110	1NC	16	F6,3
4	9451.1893	-	105	1NC	16	F6,3



afb.	bestelnr.	LA (mm)	T.uit (°C)	functie	SC (A)	aansluiting
5	9105.1220	-	115	1NC	16	F6,3
6	9395.0285	-	115	1NC	16	F6,3
7	9995.7824	-	127	1NC	16	F6,3
8	9995.7825	-	135	1NC	16	F6,3
8	9995.7826	-	150	1NC	16	F6,3



afb.	bestelnr.	LA (mm)	T.uit (°C)	functie	SC (A)	aansluiting
9	9451.1882	-	135	1NC	16	F6,3
9	NML	-	140	1NC	16	F6,3
10	9995.7827	-	145	1NC	16	F6,3
10	9995.7828	-	152	1NC	10	F6,3
10	9995.7829	-	165	1NC	16	F6,3
10	9993.7029	-	165	1NC	16	F6,3
11	9995.7830	-	165	1NC	10	F6,3
12	9995.7831	-	200	1NC	16	F6,3
12	9998.6992	-	300	1NC	16	F6,3



afb.	bestelnr.	LA (mm)	T.uit (°C)	functie	SC (A)	aansluiting
13	9995.7832	14	185	1NC	-	F6,3
13	9451.1898	23,5	85	1NC	16	F6,3
13	9451.1889	23,5	120	1NC	16	F6,3
14	9993.0419	23,5	90	1NC	16	F6,3
15	9451.1887	23,5	100	1NC	-	F6,3
16	9451.1899	23,5	105	1NC	16	F6,3



afb.	bestelnr.	LA (mm)	T.uit (°C)	functie	SC (A)	aansluiting
17	9995.7833	23,5	105	1NC	16	F6,3
17	9995.7834	23,5	110	1NC	16	F6,3
17	NML	23,5	110	1NC	16	F6,3
17	9610.0121	23,5	125	1NC	16	F6,3
17	9610.0122	23,5	135	1NC	16	F6,3
17	9610.0120	23,5	165	1NC	10	F6,3
18	9212.2020	23,5	105	NC	16	F6,3
19	9108.0128	23,5	106	1NC	16	F6,3
20	9995.7835	23,5	120	1NC	10	F6,3



afb.	bestelnr.	LA (mm)	T.uit (°C)	functie	SC (A)	aansluiting
21	9995.7836	23,5	180	1NC	16	M3
22	9995.7837	23,8	112	1NC	-	F6,3
23	9995.7838	24	130	1NC	16	F6,3
24	9344.0065	24	200	1NC	16	F6,3
24	NML	28	230	1NC	16	F6,3



afb.	bestelnr.	LA (mm)	T.uit (°C)	functie	SC (A)	aansluiting
25	9162.5105	24	210	1NC	16	F6,3
26	9998.7137	31	120	2NC	15	F6,3
26	9998.3131	40	85	2NC	16	F6,3
26	9331.0691	40	100	2NC	16	F6,3
26	9995.7839	40	105	2NC	16	F6,3
26	9998.3133	40	125	2NC	16	F6,3

Tabel wordt vervolgd op de volgende pagina



27

afb.	bestelnr.	LA (mm)	T.uit (°C)	functie	SC (A)	aansluiting
26	9998.3255	40	150	2NC	16	F6,3
26	9998.3134	40	180	2NC	16	F6,3
26	9998.3132	39-44	130	2NC	16	F6,3
26	9995.7802	39-44	135	2NC	16	F6,3
27	NML	45	62	1NC	16	F6,3

## clixonthermostaten



1 2 3 4

afb.	bestelnr.	LA (mm)	T.uit (°C)	functie	SC (A)	aansluiting
1	9995.7803	-	-	1NO/1NC	15	F6,3
2	9995.7804	-	40	1NC	10	F6,3
3	9775.0750	-	59	1NC	16	F6,3
3	NML	-	65	1NC	16	F6,3
4	9993.0687	-	65	1NO	16	F6,3

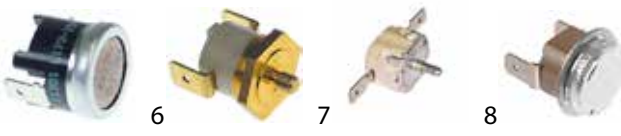

5 6 7 8

afb.	bestelnr.	LA (mm)	T.uit (°C)	functie	SC (A)	aansluiting
5	9993.0710	-	78	1NC	10	F4,8
5	9999.0146	-	95	1NC	16	F6,3
5	9993.0712	-	110	1NC	16	F6,3
5	9993.0714	-	135	1NC	10/16	F6,3
6	9993.0689	-	90	1NC	16	F6,3
6	9993.0691	-	95	1NC	16	F6,3
6	9280.2640	-	100	1NC	16	F6,3
6	9995.7805	-	103	1NC	10	F6,3
6	9993.0694	-	107	1NC	16	F6,3
6	9993.0695	-	110	1NC	16	F6,3
6	9995.7806	-	120	1NC	10	F6,3
6	9239.1040	-	125	1NC	16	F6,3
6	9993.0699	-	130	1NC	16	F6,3
6	9993.0700	-	135	1NC	16	F6,3
6	9993.0702	-	145	1NC	16	F6,3
6	9993.0703	-	150	1NC	16	F6,3
6	9993.0708	-	165	1NC	16	F6,3
7	9565.0150	-	92	1NC	16	F6,3
8	9995.7807	-	95	1NC	10	F6,3
8	9993.0499	-	120	1NC	16	F6,3
8	9993.0717	-	140	1NC	16	F6,3
8	9993.0557	-	145	1NC	16	F6,3



9 10 11 12

afb.	bestelnr.	LA (mm)	T.uit (°C)	functie	SC (A)	aansluiting
9	9993.0693	-	100	1NC	10	F6,3
10	9069.0050	-	100	1NC	16	F6,3
10	9993.0562	-	155	1NC	16	F6,3
10	9993.0563	-	165	1NC	16	F6,3
10	9993.0564	-	180	1NC	-	F6,3
11	9995.7808	-	110	1NC	-	F6,3
12	9995.7809	-	120	1NC	10	F6,3
12	9993.0707	-	160	1NC	16	F6,3



13 14 15 16

afb.	bestelnr.	LA (mm)	T.uit (°C)	functie	SC (A)	aansluiting
13	9998.5162	-	120	1NC	10	F6,3
14	9993.0559	-	160	1NC	16	F6,3
15	9995.7810	-	200	1NC	16	F6,3
16	9105.0326	-	200	2NC	16	F6,3



17 18 19 20

afb.	bestelnr.	LA (mm)	T.uit (°C)	functie	SC (A)	aansluiting
17	9690.4560	-	250	1NC	10	F6,3
18	9995.7811	-	270	1NC	-	F6,3
18	9993.0569	-	318	1NC	13,5	F6,3
19	9395.0065	-	66/57	NC/NO	16	F6,3
20	9995.7812	23,5	-	1NO	16	F6,3



21 22 23

afb.	bestelnr.	LA (mm)	T.uit (°C)	functie	SC (A)	aansluiting
21	9995.7813	23,5	45	1NO	-	F6,3
22	9995.7814	23,5	50	1NO	10	F6,3
22	9995.7815	23,5	70	1NC	10	F6,3
22	9993.0490	23,8	50	1NC	10	F6,3
23	9212.0200	23,5	55	1NC	10	F6,3
23	9995.7816	23,5	60	1NC	-	F6,3
23	9995.7817	23,5	62,8	1NC	10	F6,3
23	NML	23,5	65	NC	16	F6,3
23	9995.7818	23,5	80	1NC	16	F6,3
23	9995.7819	23,5	81	1NC	10	F6,3
23	9995.7820	23,5	90	1NO	10	F6,3

Tabel wordt vervolgd op de volgende pagina



afb.	bestelnr.	LA (mm)	T.uit (°C)	functie	SC (A)	aansluiting
23	9141.0675	23,5	110	1NC	10	F6,3
23	9995.7765	23,5	110	1NC	10	F6,3
23	9995.7766	23,5	113	1NC	10	F6,3
23	9143.0715	23,5	125	NC	-	F6,3
23	9995.7767	23,5	130	1NC	16	F6,3
23	9141.0500	23,5	138	1NC	10	F6,3
23	9995.7768	23,5	138	1NC	10	F6,3
23	NML	23,5	145	1NC	16	F6,3
23	9995.7769	23,5	149	1NC	10	F6,3
23	9998.6928	23,5	170	1NC	-	F6,3
23	9995.7780	23,5	210	1NC	16	F6,3
24	9995.7781	23,5	55	1NC	10	F6,3
24	9995.7782	23,5	110	1NC	10	F6,3
24	9993.0502	23,5	130	NC	10	F6,3
25	NML	23,5	55	1NC	16	F6,3
25	9999.4930	23,5	60	1NC	16	F6,3
25	9995.7783	23,5	62,8	1NC	10	F6,3
25	9995.7784	23,5	66	1NC	10	F4,8
25	9993.0491	23,5	70	1NC	16	F6,3
25	9993.0711	23,5	80	1NC	16	F6,3
25	9995.7785	23,5	85	1NC	10	F4,8
25	9993.0495	23,5	85	1NC	16	F6,3
25	9993.0496	23,5	86	1NC	10	F6,3
25	9995.7786	23,5	100	1NC	10	F6,3
25	9995.7787	23,5	125	1NC	-	F6,3
25	9993.0713	23,5	135	1NC	10	F6,3
25	9995.7788	23,5	140	1NC	10	F4,8
25	995.7790	23,5	148,9	1NC	10	F6,3
25	9998.7122	23,5	150	1NC	-	F6,3
25	9995.7840	23,5	150	1NC	-	F6,3
25	9995.7789	23,5	150	1NC	10	F6,3
25	9993.0565	23,5	160	1NC	16	F6,3
25	9995.7791	23,5	180	1NC	10	F4,8
25	9995.7792	23,5	180	1NC	10	F4,8
26	NML	23,5	57	1NC	15	F6,3

afb.	bestelnr.	LA (mm)	T.uit (°C)	functie	SC (A)	aansluiting
27	opvragen	23,5	57,2	1NC	-	F6,3
28	9995.7793	23,5	71	1NO	10	F6,3
29	9995.7841	23,5	73	1NC	10	F6,3
30	9993.0492	23,5	75	1NC	16	F6,3

afb.	bestelnr.	LA (mm)	T.uit (°C)	functie	SC (A)	aansluiting
31	9995.7795	24	150	NC	15	F6,3
32	9993.0497	30	90	1NO	10	F6,3
33	9995.7796	34	91	2NC	-	F6,3
34	9162.1008	38	53	1CO	16	F6,3
34	9993.0681	38	55	1NC	16	F6,3
34	NML	40	55	1CO	16	F6,3
34	NML	40	80	1NC	16	F6,3
34	9995.7797	40	100	1NC	16	F6,3
34	9985.7799	46	130	1NC	16	F6,3

afb.	bestelnr.	LA (mm)	T.uit (°C)	functie	SC (A)	aansluiting
35	9162.1512	40	60	1CO	16	F6,3
36	9993.0685	40	85	1NC	16	F6,3
37	9108.0058	40	115	1NC	16	F6,3
38	ABJ083524	40	55/42	NC/NO	16	F6,3

## overigen

afb.	bestelnr.	T.uit (°C)	functie	SC (A)	V (V)	aansluiting
1	9995.7799	-	-	-	-	-
2	9995.7800	-	1NC	10	250	M4
3	opvragen	-	1NO	-	-	F6,3
4	9995.7801	300	1CO	10	250	F6,3



per fabrikant

EGO

regelthermostaten

serie 51\_

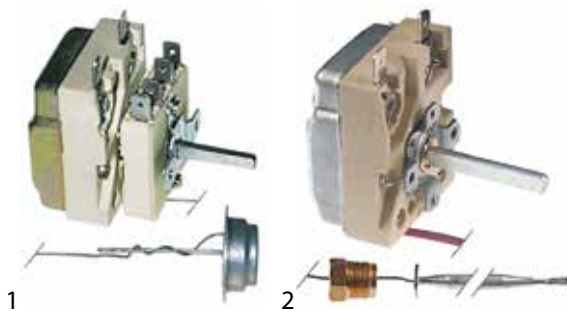

afb.	bestelnr.	t.max. (°C)	t.ber. (°C)	aantal polig (-polig)	functie	SC (A)	voeler ø (mm)	voeler L (mm)	cap. (mm)	capillaire pijp geïsoleerd (mm)	stopbus	as L (mm)	passend voor	fabrikantnr.
1	9315.0048	93	30-93	1	1NO	15	20/23,5	11	900	800	-	25	Angelo-Po EGO EGO Sagi	32Z0410 51.41918.500 55.13612.150 32Z0410
2	9220.0218	110	85-110	1	1NO	15	6	265	2990	1700	-	35	EGO Küppersbusch	51.09995.010 174637

serie 55.10/19\_

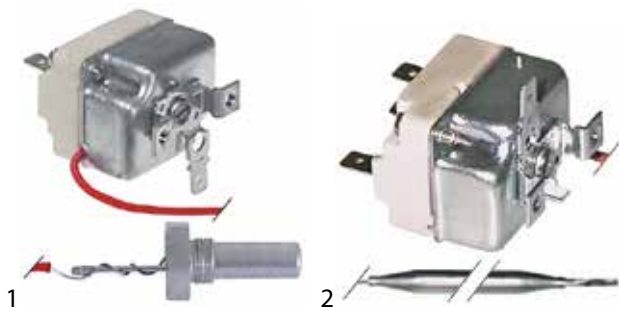

afb.	bestelnr.	t.max. (°C)	t.ber. (°C)	aantal polig (-polig)	functie	SC (A)	voeler ø (mm)	voeler L (mm)	cap. (mm)	capillaire pijp geïsoleerd (mm)	stopbus	as L (mm)	passend voor	fabrikantnr.
1	9690.2270	50	vast 50	1	1CO	16	11	45	850	830	-	-	EGO EGO Elframo Komel	55.19302.810 55.19312.020 00057151 00057151
2	9690.1205	55	vast 55	1	1NO	16	6	130	900	850	-	-	EGO Lainox	55.19112.800 LAR65070100
2	9342.0000	60	vast 60	1	1CO	16	6	129	1470	1430	-	-	Adler EGO Electrolux	20110 55.19314.801 070311
2	9690.1240	65	vast 65	1	1CO	16	6	130	900	900	-	-	Angelo-Po EGO Lainox	32Z2430 55.19222.810 LAR65070165
2	9690.1245	70	vast 70	1	1CO	16	6	130	900	900	-	-	EGO Lainox	55.19222.811 LAR65070240
2	9162.2672	76	vast 76	1	1CO	16	3,1	226	870	870	-	-	EGO Electrolux	55.19312.801 056671
2	NML	85	vast 85	1	1CO	16	6	129	1470	1430	-	-	Adler Bartscher EGO	20119 0481927128594 55.19314.800
2	9690.4065	90	30-90	1	1CO	16	6	102	1000	960	-	-	EGO Mach	55.17219.020 500063900
2	9690.1300	90	19-90	1	1CO	16	6	129	2970	2850	-	-	EGO	55.19216.010

Tabel wordt vervolgd op de volgende pagina

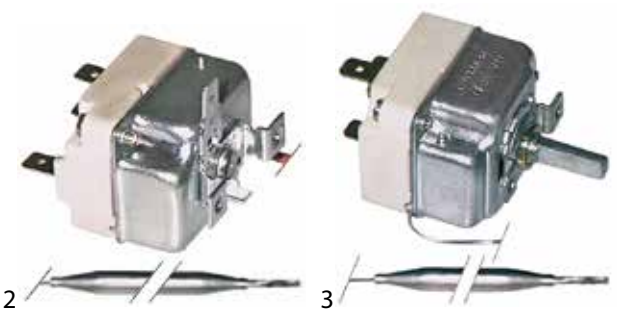
afb.	bestelnr.	t.max. (°C)	t.ber. (°C)	aantal polig (-polig)	functie	SC (A)	voeler ø (mm)	voeler L (mm)	cap. (mm)	capillaire pijp geïsoleerd (mm)	stopbus	as L (mm)	passend voor	fabrikantnr.
2	9690.1285	90	19-90	1	1CO	16	6	129	980	960	-	-	EGO Elframo Emmepi Komet	55.19219.825 22180004 809260 22180004
2	9690.1250	142	vast 142	1	1CO	16	4	157	870	870	-	-	Ambach Baron EGO Krefft Mareno Silko	5061609772 CR0682740 55.19322.801 42-5061609772 CR0682740 CR0682740
2	9690.1260	150	vast 150	1	1CO	16	6	130	900	700	-	-	EGO Gico	55.19322.808 53400112150
2	9690.1290	150	vast 150	1	1NO	0,5	6	86	1000	-	-	-	Ambach EGO	5061603920 55.10129.827
2	9690.1255	150	vast 150	1	1NO	16	6	74	900	900	-	-	Angelo-Po EGO	32Z9380 55.19122.803
3	9690.4746	60	vast 60	1	1NO	16	6	134	1800	-	-	-	Morice	TH1123
3	9690.4717	70	30-70	1	1NO	16	6	129	900	900	-	23	EGO Ilsa	55.19012.823 31482
3	9998.6639	85	30-85	1	1CO	16	6	130	900	900	-	23	EGO Lasa Mareno	55.19212.802 3267320 1037314600
3	9690.1305	86	30-82	1	1CO	16	3	156	600	600	-	8,5	EGO Krefft Palux	55.19219.821 62-236037 376035
3	9690.2345	90	30-90	1	1CO	16	6	130	2500	-	M10x1	23	Angelo-Po EGO	32Z0160 55.19219.819
3	9280.1020	90	30-90	1	1CO	16	6	130	2040	1940	-	23	Angelo-Po EGO EGO Electrolux Kelvin Mareno Olis Silko Teikos Zanussi	32V0200 55.19012.806 55.19219.810 003262 0101103 MA7800300 A046260 SIR0101403 843601 003262
3	9690.0094	90	30-90	1	1CO	16	15	22,5	1700	-	-	16	Angelo-Po Bonnet EGO EGO Elettrobar	32Z0450 3650E 55.10219.820 55.19219.010 236002
3	9610.0135	90	30-90	1	1NO	16	6	130	900	600	M9x1	18	EGO Lotus Rosinox	55.19012.801 537001500 RX94805249
3	9162.1586	90	30-90	1	1NO	16	6	130	2000	2000	-	23	EGO EGO Emainox Olis	55.19019.806 55.19019.822 3700002 BN6A046050
3	9690.4070	90	30-90	1	1NO	16	6	130	1800	1800	-	23	EGO Electrolux Juno Sogeco	55.19015.800 0K3061 0K3061 03-THR-090
3	9191.0074	91	25-90	1	1CO	16	6	174	900	900	-	23	EGO EGO EGO Palux	55.10212.190 55.19212.800 55.19212.806 337609
3	9108.0158	95	30-90	1	1CO	16	6	138	860	-	M9x1	23	Animo Bonnet EGO EGO	03090 1244788 55.10212.100 55.19212.020

Tabel wordt vervolgd op de volgende pagina



afb.	bestelnr.	t.max. (°C)	t.ber. (°C)	aantal polig (-polig)	functie	SC (A)	voeler ø (mm)	voeler L (mm)	cap. (mm)	capillaire pijp geïsoleerd (mm)	stopbus	as L (mm)	passend voor	fabrikantnr.
3	9690.2193	110	30-110	1	1CO	16	6	130	1500	-	-	23	Alpeninox EGO Electrolux Emmepi GIGA Silko Star10 Zanussi	0A2018 55.19224.801 0A2018 828838 X43100 SIR0101383 X43100 0A2018
3	9690.0344	110	30-110	1	1NO	16	6	130	2000	2000	-	23	EGO Olis	55.19029.800 BN6A046105
3	9366.0010	110	30-110	1	1NO	16	6	130	900	900	-	23	EGO	55.19022.804
3	9690.4748	110	0-110	1	1NO	16	6	140	875	780	M9x1	23	Rosinox	RX94016615
3	9690.4075	110	31-110	1	1NO	16	6	133	870	-	-	23	Bertos EGO Foinox Olis	25070800 55.19022.808 10005 BN6A046100
3	9690.2218	110	33-110	1	1CO	16	6	138	880	870	-	23	EGO Gico	55.19222.809 53401030110
3	9033.3320	112	30-110	1	1NO	16	6	130	900	-	M9x1	23	Ambach Fry_logic CB EGO EGO EGO EGO Haka MKN Modular Morice	5061602949 9033.3320 09010015 55.10022.010 55.10022.910 55.19022.801 55.19022.819 9040 203498 66100400 TH1081
3	9690.4074	140	50-140	1	1NO	0,5	6	107	860	-	-	23	EGO EGO Electrolux Juno	55.10022.340 55.19022.080 0H6126 0H6126
3	9105.1405	150		1			6	135	710				Bonamat EGO	6.016.005.035 55.19019.855
3	9025.0655	150	60-150	1	1NO	16	3	144	1600	1600	-	23	Bertos EGO EKU Firex GIGA Lincar Offcar Olis	35301000 55.19029.806 4-FI-004 40100050 E10600 40010010 FX40100050 6A001414
3	9162.4098	150	60-150	1	1NO	16	3	219	900	900	-	23	Bertos EGO Emmepi Silko	31290000 55.19022.813 809036 SIR0102492
3	NML	170	85-170	1	1NO	16	4	231	900	600	-	23	EGO EGO Tecnoinox	55.19032.803 55.19032.818 RC00038000
3	9690.4085	170	85-170	1	1NO	16	4	231	900	850	M9x1	23	EGO Olis	55.19032.808 BN9000216
3	9690.4090	171	85-171	1	1NO	16	6	133	870	700	-	23	Baron EGO	41826630370 55.19032.838
3	9691.0160	175	45-170	1	1NO	16	3	219	900	900	-	23	EGO Electrolux Zanussi	55.19032.850 031480 031480
3	9000.0340	180	70-180	1	1NO	16	6	87	1500	-	-	23	EGO Star10	55.19034.805 072001.1
3	9000.2025	180	70-180	1	1NO	16	6	87	600	350	-	23	EGO Forved MBM-Italia Pieffe Saro	55.19039.815 3064 161791 0020 122-2002
3	9690.4095	180	80-180	1	1NO	16	6	135	900	-	M9x1	23	Bonnet Capic EGO EGO Morice Solymac	7471024 E401075 55.10032.207 55.19032.203 TH1112 P77
3	9690.4100	180	95-180	1	1NO	16	6	130	1500	1100	-	23	EGO Electrolux OEM Tecnoinox	55.19034.800 006749 ED04800 RC00779000

Tabel wordt vervolgd op de volgende pagina



3

afb.	bestelnr.	t.max. (°C)	t.ber. (°C)	aantal polig (-polig)	functie	SC (A)	voeler ø (mm)	voeler L (mm)	cap. (mm)	capillaire pijp geïsoleerd (mm)	stopbus	as L (mm)	passend voor	fabrikantnr.
3	9690.2410	182	93-180	1	1NO	16	6	133	2020	1800	-	23	EGO EGO Gico	55.19039.100 55.19039.808 5340101
3	9690.4105	182	95-180	1	1NO	16	6	133	870	-	M9x1	13	Angelo-Po EGO	32V4540 55.19032.813
3	9690.1095	182	95-182	1	1NO	16	6	133	870	750	M9x1	23	Baron EGO EGO	BN41826630372 55.19032.070 55.19032.812
3	9690.4110	184	80-184	1	1NO	16	6	87	570	-	-	23	EGO Star10	55.19039.816 072020.1
3	9475.0455	185	100-185	1	1NO	16	4	231	1800	1600	M9x1	23	Ambach EGO	5061610987 55.19035.802
3	9690.4115	185	105-185	1	1NO	16	6	130	900	700	M10x1	23	EGO VEGA	55.19032.831 93238
3	9690.2395	187	101-185	1	1NO	16	6	133	870	520	M10x1	23	Angelo-Po EGO MBM-Italia	3168460 55.19032.100 173501
3	9162.1268	188	90-185	1	1NO	16	4	231	1300	1300	-	23	EGO EGO Electrolux	55.10039.807 55.19039.800 050412
3	9025.0230	190	100-190	1	1NO	16	6	130	1800	1200	M9x1	23	EGO GIGA Ilsa Star10	55.19035.800 Y16000 60775 Y16000
3	9700.0345	190	104-190	1	1NO	16	6	133	870	-	M9x1	23	EGO EGO Electrolux Fimar Lotus Mareno	55.19032.040 55.19032.805 0KJ142 CO1111 537014300 MA1037035800
3	9690.4120	190	105-190	1	1NO	0,5	4	235	1470	1250	M10x1	23	EGO EGO Elframo Repagas	55.19034.020 55.19034.070 22140004 64100014
3	9690.4125	190	48-190	1	1NO	16	6	107	1470	-	M9x1	23	EGO Falcon	55.19034.040 731750711
3	9023.0010	190	80-190	1	1NO	16	6	87	570	-	-	23	EGO Faba	55.19039.822 PR70009
3	9700.1375	192	100-190	1	1NO	16	6	130	3000	2650	M9x1	23	EGO EGO EGO Mareno	55.10033.800 55.19036.800 55.19036.801 MA1981900
3	9999.5245	192	100-192	1	1NO	16	4	235	870	-	-	21	EGO Olis	55.19032.807 A049100
3	NML	192	96-192	1	1NO	16	4	235	870	650	-	21	EGO	55.19032.840
3	9998.1695	195	60-195	1	1NO	16	4	89	600	-	-	23	EGO Elframo Komel	55.19039.805 22140001 22140001
3	9475.0345	195	65-195	1	1NO	16	4	106	1470	-	-	23	EGO Elframo Repagas	55.19034.060 22140002 8500014
3	9095.1005	200	60-200	1	1NO	16	6	74	1500	-	-	23	Cuppone EGO Electrolux Moretti Pizza-Group	ME0000303 55.19034.802 0C6949 74220840 A88TX77002
3	9998.1750	211	35-200	1	1CO	16	6	74	1500	-	-	23	EGO EGO Foem	55.19234.800 55.19234.801 05000087150

Tabel wordt vervolgd op de volgende pagina





afb.	bestelnr.	t.max. (°C)	t.ber. (°C)	aantal polig (-polig)	functie	SC (A)	voeler ø (mm)	voeler L (mm)	cap. (mm)	capillaire pijp geïsoleerd (mm)	stopbus	as L (mm)	passend voor	fabrikantnr.
3	9690.2596	249	55-249	1	1NO	16	3,1	226	1270	850	3/8"-M8x1	23	Angelo-Po Convotherm EGO	32Z5820 5001032 55.19059.809
3	9690.4130	250	48-250	1	1NO	16	3,03	160	1270	-	-	23	EGO Star10	55.19049.803 072032
3	9690.0376	250	55-250	1	1CO	16	3,1	226	1170	1100	M9x1	23	EGO Eloma Falcon Küppersbusch Palux	55.10243.010 55.19243.010 EL0091634 530091634 540522 091634
3	9690.4749	250	55-250	1	1NO	16	3,1	226	2420	1100	-	23	EGO Eloma	55.19049.010 ELE334002
3	9690.2240	255	45-255	1	1CO	16	6	74	900	900	-	23	CB EGO Emmepi	09010014 55.19252.807 C00545
3	9029.0004	255	50-255	1	1NO	16	3	219	900	-	-	23	EGO EGO	55.10052.850 55.19052.803
3	9162.1508	260	50-260	1	1NO	16	4	115	1300	1300	-	23	EGO Electrolux Juno Zanussi	55.19059.803 051360 051360 051360
3	9965.0210	262	58-258	1	1NO	16	3	226	870	330	-	23	EGO	55.19052.817
3	9690.4140	265	50-265	1	1NO	16	3	219	900	800	M9x1	23	EGO Inoxtrend	55.19052.832 C2190-00
3	9690.4145	269		1	1NO	16	3	225	900	800	-	23	EGO Unox	55.19052.808 TR1100A0
3	9690.4150	270	40-270	1	1NO	16	3	145	900	900	-	23	EGO Smeg	55.19052.837 818730033
3	9690.2214	270	50-270	1	1CO	16	3	219	3000	2500	M10x1	23	EGO Mareno	55.19256.800 MA2992900
3	9690.4155	270	50-270	1	1NO	16	3	219	900	900	-	23	EGO MBM-Italia	55.19052.846 RTC0600186
3	9690.4160	273	57-273	1	1NO	16	3,1	226	1470	1250	M9x1	23	EGO Inoxtrend	55.19054.010 LC352
3	9025.0021	280	50-280	1	1NO	16	3	228	1300	1150	-	23	Bertos EGO EGO Gico GIGA Lainox Mareno Modular	22061900 55.19043.850 55.19059.805 53401005270 X49600 LAR65070210 R65070210 66107300
3	9162.2894	280	55-269	1	1CO	16	3,1	219	1280	1270	-	23	Angelo-Po Bertos EGO EGO Electrolux Foinox Gico GIGA Lainox Star10	32Z0610 23900600 55.19059.808 55.19259.811 057937 0596 53401005270 X43600 LAR50304031 X43600
3	9162.2440	287	60-287	1	1NO	16	3,1	226	1470	350	-	23	Bonnet Capic EGO Electrolux Thirode Zanussi	301031 E401082 55.19054.801 054323 301031 054323
3	9690.4750	289	57-289	1	1NO	16	3,1	226	1780	1770	-	23	Coven EGO Sogeco	EMTS0300 55.19055.800 03-THR-270
3	9280.2300	293	55-293	1	1NO	16	3,1	226	870	350	-	23	Cookmax EGO Unox	KTR009 55.19052.861 KTR009
3	9690.4422	295	45-295	1	1NO	16	3	219	1300	350	-	23	Cookmax EGO Olis	A049200 55.19053.807 BN6A049200

Tabel wordt vervolgd op de volgende pagina

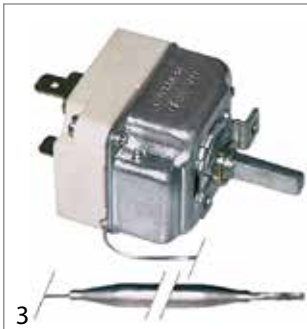

afb.	bestelnr.	t.max. (°C)	t.ber. (°C)	aantal polig (-polig)	functie	SC (A)	voeler ø (mm)	voeler L (mm)	cap. (mm)	capillaire pijp geïsoleerd (mm)	stopbus	as L (mm)	passend voor	fabrikantnr.
3	9690.4170	295	45-295	1	1NO	16	4	100	900	350	-	23	EGO EGO GIGA Lincar Lotus Offcar Rosinox Silko Star10	55.19052.813 55.19052.843 X49800 40000906 40100042 FX40100042 RX94812577 SIR0101377 X49800
3	9690.4175	296	50-275	1	1NO	16	3	133	900	900	-	43	EGO Smeg	55.19052.890 818731128
3	9162.5585	296	65-296	1	1NO	16	3,1	226	980	980	-	23	EGO Electrolux Juno Lainox Zanussi	55.19059.831 056384 056384 LAR65070360 056384
3	9690.4180	297	58-297	1	1NO	16	3,03	219	870	-	-	23	Anitec Bertos EGO Electrolux Star10 Tecnoinox	072005 23063600 55.19052.830 006941 072005 RC00769000
3	9690.2420	298	55-294	1	1NO	16	3,1	226	870	350	-	23	Cookmax EGO Hobart Mareno Silko	1037102300 55.19052.812 144451108 MA1037102300 MA1037102300
3	9025.0405	300	50-300	1	1NO	16	6	74	900	-	-	23	EGO GIGA Techfood	55.19052.825 Y19200 CE00091
3	9690.4185	315	65-315	1	1NO	-	3,03	196	870	-	-	23	EGO	55.19052.819
3	9120.0100	318	60-318	1	1NO	16	3,03	139	870	-	-	23	EGO Tecnoeka	55.19062.813 01200370
3	9690.4190	320	50-320	1	1NO	16	3	145	900	900	-	23	EGO Smeg	55.19062.820 818730130
3	9690.4195	320	50-320	1	1NO	16	3	219	900	700	-	23	EGO Indesit Star10	55.19062.806 C00066814 16001142401
3	9690.4200	320	50-320	1	1NO	16	3	226	880	865	-	23	EGO Rosinox	55.19062.204 RX94024957
3	9280.3045	320	55-320	1	1NO	16	3,1	226	870	850	-	23	Bartscher Bertos Bonnet Bourgeois CB Dihl EGO EGO EGO EGO Electrolux Emmepi Faba Fimar Foinox Forved GIGA Kromo MBM-Italia Silanos Star10 Tecnoinox Zanulli Zanussi	A010401 22063600 7471032 THER001 09010021 DW9010 55.10062.010 55.19052.818 55.19062.800 55.19062.802 004939 C00563 PR10009 CO1941 0026 GRILLTERMOS X68205 DW9010 RTCU700455 907130 X68205 RC00569000 ELET0013 004939

Tabel wordt vervolgd op de volgende pagina

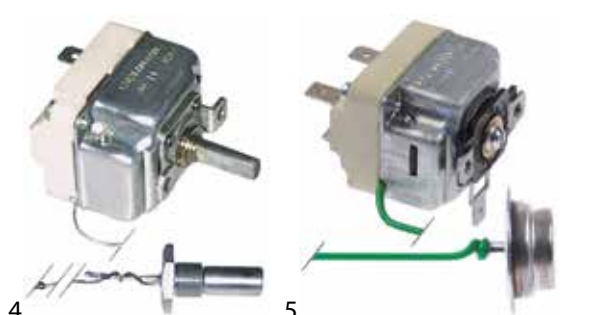
afb.	bestelnr.	t.max. (°C)	t.ber. (°C)	aantal polig (-polig)	functie	SC (A)	voeler ø (mm)	voeler L (mm)	cap. (mm)	capillaire pijp geïsoleerd (mm)	stopbus	as L (mm)	passend voor	fabrikantnr.
3	9690.4205	320	57-320	1	1NO	16	3,1	226	870	870	-	15	Ambach EGO	5061618075 55.19062.845
3	9690.4210	320	64-320	1	1NO	0,5	4	124	1470	-	-	23	Baron Cookmax EGO EGO Olis	41826630191 41826630191 55.10064.800 55.19064.020 BN826630191
3	9690.4215	324	66-324	1	1NO	16	4	124	1470	-	-	23	Angelo-Po EGO Fimar	32Z0210 55.19064.800 CO1941
3	9690.3099	325	55-325	1	1NO	16	3,03	120	600	-	-	23	EGO Tecnoeka	55.19069.858 01201230
3	9690.4220	355	60-355	1	1NO	16	4	228	900	600	-	23	EGO Unox	55.19082.806 KTR1131A
3	9690.4225	358	60-358	1	1NO	16	3,03	178	870	870	-	23	EGO Heidebrenner OEM	55.19072.802 94229 ED00700
3	9690.4230	400	65-400	1	1NO		3,9	163	870	600	-	23	EGO Mareno	55.19082.812 MACM293801
3	9690.4235	415	65-415	1	1NO	16	3,9	228	870	660	-	23	Anitec EGO Star10	072039 55.19072.805 072039
3	9690.4240	422	65-422	1	1CO	16	4	230	900	630	-	23	EGO OEM	55.19272.801 ED05800
3	9095.0116	450	85-450	1	1NO	16	3,9	228	870	660	-	23	CB Cookmax Cuppone EGO EGO Electrolux Faba Fornitalia GAM GMG Moretti Pizza-Group	09010027 74300110 91310003 55.19082.805 55.19082.808 004155 PR13012 40/60Z17 RG100417 PI-B148 74300110 A88TX77005
3	9690.4245	470	90-470	1	1NO	16	3,9	163	870	600	-	23	Baron EGO Mareno Silko	CR0734520 55.19082.809 CR0734520 CR0734520
3	9690.2434	500	75-500	1	1NO	16	3,9	228	1470	960	-	23	Alpeninox EGO Electrolux Moretti Zanussi	056701 55.19084.800 056701 74310830 056701
3	9094.0415	500	75-500	1	1NO	16	4	228	900	-	-	23	Cuppone EGO Fage Fimar GGF Izmak	ME0000300 55.19082.802 EGO50092 CO3601 TERMO001 101001
4	9690.2350	90	30-90	1	1CO	16	11	28	1000	1000	-	23	EGO Krefft Teikos	55.19219.815 62-236002 843621
4	9026.0122	170	70-170	1	1NO	16	11	28	900	900	-	23	Bertos Bonnet EGO GIGA Silko	22064932 70707E 55.19032.825 0000X43300 SIR0109054
5	9998.6206	90	30-90	1	1CO	16	20	12	1500	-	-	-	EGO Mach	55.19214.826 500070700

Tabel wordt vervolgd op de volgende pagina



afb.	bestelnr.	t.max. (°C)	t.ber. (°C)	aantal polig (-polig)	functie	SC (A)	voeler ø (mm)	voeler L (mm)	cap. (mm)	capillaire pijp geïsoleerd (mm)	stopbus	as L (mm)	passend voor	fabrikantnr.
6	9690.4250	90	35-90	1	1NO	16	11	24	900	900	-	23	EGO Modular	55.19012.814 66107000
7	9690.0645	182	100-180	1	1NO	16	11	28	850	800	-	23	Angelo-Po EGO	32Z2940 55.19032.010
8	9690.4255	185	106-185	1	1NO	16	8	89	850	360	-	23	EGO	55.19032.816
9	9690.4260	200	150-200	1	1NO	16	6	79	860	610	M9x1	23	EGO Rosinox	55.19039.202 RX94016680

afb.	bestelnr.	t.max. (°C)	t.ber. (°C)	aantal polig (-polig)	functie	SC (A)	voeler ø (mm)	voeler L (mm)	cap. (mm)	capillaire pijp geïsoleerd (mm)	stopbus	as L (mm)	passend voor	fabrikantnr.
10	9690.4265	308	65-308	1	1NO	16	3,03	120	600	-	-	23	EGO Tecnoeka	55.19069.859 09952637000
10	9690.4270	320	50-320	1	1NO	16	3	120	1200	-	-	23	Bonnet EGO EGO Indesit Lotus	2050031 55.19063.804 55.19069.831 C00089745 537019100

## Serie 55.13\_

afb.	bestelnr.	t.max. (°C)	t.ber. (°C)	aantal polig (-polig)	functie	SC (A)	voeler ø (mm)	voeler L (mm)	cap. (mm)	capillaire pijp geïsoleerd (mm)	stopbus	as L (mm)	passend voor	fabrikantnr.
1	9690.4275	80	vast 80	1	1NC	16	6	95	1470	1100	-	-	EGO Rieber	55.13114.020 33061505
1	9162.1262	83	29-83	1	1CO	16	6	115	870	-	-	-	EGO Electrolux Zanussi	55.13212.640 0L2122 0L2122
1	9690.2270	95	27-95	1	1NO	16	4	203	1230	800	-	-	EGO Hobart	55.13019.920 886638
2	9690.2257	82	vast 82	1	1CO	-	15/9	21	1000	950	-	-	EGO Fagor	55.13319.040 12024939
3	9690.2315	85	20-85	1	1NO	16	4	124	870	790	-	15	EGO Hupfer	55.13012.900 014001214-02
3	9690.2250	85	30-85	1	1CO	16	6	73	1540	1400	M9x1	23	EGO Fagor	55.13219.310 12024648

Tabel wordt vervolgd op de volgende pagina



afb.	bestelnr.	t.max. (°C)	t.ber. (°C)	aantal polig (-polig)	functie	SC (A)	voeler ø (mm)	voeler L (mm)	cap. (mm)	capillaire pijp geïsoleerd (mm)	stopbus	as L (mm)	passend voor	fabrikantnr.
3	9998.0280	85	30-85	1	1CO	16	6	92	3150	300	-	23	Bartscher Cookmax EGO Electrolux Elettrobar GIGA Palux Zanussi	040575 040575 55.13212.410 55.13219.140 069422 236046 — 349313 069422
3	9010.0118	85	30-85	1	1CO	16	6	113	2930	500/300	-	23	EGO Krefft	55.13216.020 602865
3	9030.0155	85	30-85	1	1NO	16	6	92	830	-	-	23	EGO EKU Roka Roller-Grill Wiesheu-Wiwa	55.13012.010 10-44 8900203 A06041 33003
3	9705.7495	90	30-90	1	1CO	16	6	98	2380	1700	M9x1	18	EGO Fagor MKN Roller-Grill	55.13219.440 12024096 203173 A06021
3	9406.0900	90	0-90	1	1CO	16	3,1	247	1430	1400	-	18	EGO Krefft Küppersbusch Rational Rosinox	55.13214.160 76-30140312 407279 3014.0312 RX24848145
3	9690.2203	90	32-90	1	1CO	16	6	129	710	500	-	23	EGO Fagor	55.13219.320 12024573
3	9691.0215	90	71-90	1	1NO	16	3,1	201	900	120	-	25	EGO Falcon	55.13012.560 732920055
3	9690.2312	91	30-91	1	1CO	16	3,1	201	1730	210	-	15	EGO Hupfer	55.13215.250 014001213
3	9690.4751	93	28-93	1	1NO	16	3,1	244	710	650	-	23	EGO	55.13019.730
3	9690.4752	93	28-93	1	1NO	16	3,1	244	710	650	-	23	Winterhalter	3125047
3	9690.4753	93	30-93	1	1CO	16	6	90	1780	1870	M9x1	11	EGO	55.13215.050
3	9690.4754	93	30-93	1	1CO	16	6	98	830	-	M9x1	23	EGO Lincat	55.13212.330 TH27
3	9690.2262	93	31-93	1	1CO	16	6	98	2380	-	M9x1	23	EGO Jemi	55.13219.330 2006053
3	9690.2332	96	31-96	1	1NO	16	6	94	980	-	-	23	EGO	55.13019.420
3	9690.4755	96	82-96	1	1CO	16	6	147	870	-	M9x1	23	Corsair EGO Lincat	01-027 55.13212.370 TH09
3	9690.2251	105	52-105	1	1CO	16	3,03	201	2380	2200	M9x1	23	EGO Fagor	55.13229.060 12018245
3	NML	110			NO	16	6	78	980	600	M9x1	27	Ambassade EGO	65224008 55.13022.750
3	9835.0095	110	30-110	1	1CO	16	3,1	197	3150	300	-	23	EGO EGO Küppersbusch	55.13224.060 55.13229.030 174690
3	9690.0114	110	30-110	1	1CO	16	6	113	870	-	-	23	EGO	55.13222.010
3	9162.1434	110	30-110	1	1CO	16	6	113	2930	-	M9x1	23	EGO Electrolux Therma Zanussi	55.13226.030 0E5032 0E5032 0E5032
3	9690.0042	110	30-110	1	1NO	16	6	113	870	-	M9x1	25	Ambassade CoffeeQueen EGO EGO EGO EGO Franke Giorik Hobart Lincar Roka Roller-Grill Salvis	6528195 160214 55.13022.010 55.13022.020 55.13022.180 55.13022.390 178983 6010015 139866-48 40000901 8900202 A06044 178983
3	9338.0771	110	30-110	1	1NO	16	6	115	1130	800	-	23	Blue Seal EGO Electrolux Juno	— 55.13023.030 55.13024.050 0K0659 0K0659

Tabel wordt vervolgd op de volgende pagina



3

afb.	bestelnr.	t.max. (°C)	t.ber. (°C)	aantal polig (-polig)	functie	SC (A)	voeler ø (mm)	voeler L (mm)	cap. (mm)	capillaire pijp geïsoleerd (mm)	stopbus	as L (mm)	passend voor	fabrikantnr.
3	9690.0238	110	30-110	1	1NO	16	6	115	1430	-	M9x1	23	Ambassade Bartscher EGO Morice Scholl	6528193 06528193 55.13024.020 TH0117 70,10,02
3	9999.4290	115	30-115	1	1NO	16	4	124	1730	800	-	15	EGO Hupfer	55.13025.040 014034027-01
3	9690.4756	116	36-116	1	1NO	16	6	113	870	350	M9x1	23	EGO MKN	55.13022.370 203490
3	9526.0045	120	30-120	1	1NO	16	6	85	2970	2950	-	18	EGO Mobile-Containing Scholl	55.13026.050 957050 70,10,30
3	9690.2266	125	30-125	1	1CO	16	3,03	160	2290	1710	-	23	EGO Küppersbusch	55.13229.050 174690
3	9690.2314	135	30-135	1	1NO	16	4	124	830	210	-	15	EGO Hupfer	55.13022.530 014040228-01
3	9690.4757	150	30-150	1	1NO	16	6	84	850	-	-	23	EGO MKN	55.13022.110 203760
3	9690.4276	175	101-175	1	1NO	16	6	98	870	800	-	23	Ambassade Bartscher EGO	6528195 021899 55.13032.370
3	9998.0415	180	60-180	1	1CO	16	6	90	2400	2300	-	25	EGO Krefft Küppersbusch Rational	55.13239.020 76-30140314 407340 3014.0314
3	9287.0393	185	97-185	1	1NO	16	6	87	1430	1100	M9x1	23	Bertos Cometto EGO EKU MKN Rosinox	33065600 COM50016 55.13034.100 4-117 203662 RX24848269
3	9690.4277	190	0-190	1	1NO	16	6	115	550	260	-	20	EGO Hendi	55.13039.340 205228
3	9690.4278	190	130-190	1	1NO	-	6	117	890	-	M9x1	25	EGO Lincat Mirror	55.13032.260 TH29 XXEG5532543030
3	9000.0027	190	60-190	1	1NO	16	6	77	870	-	-	23	Bartscher EGO	A039882 55.13032.400
3	9999.5806	190	94-190	1	1NO	16	6	94	1090	960	M10x1	23	Baron Bartscher EGO Electrolux Emmepi Giorik Ilsa Lincar MBM-Italia Offcar Rosinox Silko Zanussi	85326010005 014231 55.13039.300 058163 808935 6010005 31229 40000955 RTBF800163 862115 RX94805371 SIR0108014 058163
3	9690.2319	190	97-190	1	1NO	16	6	87	1430	1100	M9x1	23	EGO MKN	55.13034.120 203067
3	9690.4280	195	100-195	1	1NO	16	4	157	2250	2020	-	18	EGO Falcon FriFri GIGA	55.13039.110 737400541 400541 FZ400541

Tabel wordt vervolgd op de volgende pagina



afb.	bestelnr.	t.max. (°C)	t.ber. (°C)	aantal polig (-polig)	functie	SC (A)	voeler ø (mm)	voeler L (mm)	cap. (mm)	capillaire pijp geïsoleerd (mm)	stopbus	as L (mm)	passend voor	fabrikantnr.
3	9690.0244	200	60-200	1	1NO	16	6	77	870	-	M9x1	23	EGO EGO EGO EGO FriFri Jemi	55.13032.010 55.13032.390 55.13032.430 55.13032.550 100374 2006001
3	9344.0252	200	68-200	1	1NO	16	6	78	870	-	-	25	Bartscher EGO	0KG20509 55.13032.450
3	9690.2216	215	60-215	1	1NO	16	3,1	201	870	600	M9x1	23	EGO Fagor	55.13042.290 12024623
3	9690.2200	215	60-215	1	1NO	16	6	77	2250	2100	-	23	EGO Fagor	55.13039.120 12024662
3	ABJ082000	250	50-250	1	1CO	16	3,1	160	1430	800	M9x1	23	EGO Electrolux Juno	55.13244.010 0H6439 0H6439
3	9690.2206	250	50-250	1	1NO	16	3,1	201	2970	-	-	23	Bourgeois EGO Wiesheu-Wiwa	THER019 55.13046.010 Sach.Nr.61902,36113
3	9215.0024	250	50-250	1	1NO	16	3,1	208	1130	-	-	23	EGO EGO Küppersbusch MIWE Morice Whirlpool Wiesheu-Wiwa	55.13043.010 55.13043.060 174664 504024.16 TH0111 481227118033 34352
3	9690.4282	250	50-250	1	1NO	16	6	62	1450	-	-	16	EGO Hendi	55.13044.050 923092
3	9998.0090	255	50-255	1	1CO	16	3,03	160	1430	800	-	23	EGO Electrolux Juno	55.13254.030 0K0646 0K0634
3	9998.6003	255	55-255	1	1NO	16	3,1	201	1170	1100	-	23	EGO Fagor	55.13043.060 12018390
3	9405.0002	258	58-258	1	1NC	16	3,1	201	1130	-	-	23	Convotherm EGO	5001021K 55.13053.180
3	9013.0016	300	50-300	1	1CO	16	3,03	160	1130	1103	-	23	Ambassade Bartscher EGO EGO Küppersbusch Rational	6553670 06553670 55.13062.140 55.13253.010 407276 3014.0311
3	9690.4283	300	50-300	1	1NO	16	4	91	1130	1100	-	23	EGO MKN Palux	55.13053.140 203248 637718
3	9406.0875	300	60-300	1	1CO	16	4	98	1450	-	-	25	EGO Krefft Rational	55.13254.040 76-30140166 3014.0166
3	9998.0505	300	60-300	1	1NO	16	4	100	830	800	-	15	EGO Krefft Küppersbusch Rational	55.13052.150 76-30140318 407266 3014.0318
3	9690.2202	310	50-310	1	1NO	16	3,03	160	1130	800	-	23	EGO	55.13063.160
3	9344.0005	320	50-320	1	1NO	16	3	160	870	-	-	23	Anitec Ascobloc Bartscher Chergui Cooking-Systems Corsair EGO EGO EGO EKU Electrolux Falcon Foem Hendi Jemi Juno Küppersbusch Lotus Mareno MKN Palux Roller-Grill RSI Star10 Therma Wiesheu-Wiwa	RG.A06042 8174681 030008099 03EDTH0020, EDTH002 2221 01-056 51.03915.020 55.13062.040 55.13069.500 15-BA-18 0H2049 539113110 03051500140 902011 2006061 0H2049 174681 537006100 MA643800 203500 202029 A06042 30008099 RG.A06042 0H2049 33073

Tabel wordt vervolgd op de volgende pagina



afb.	bestelnr.	t.max. (°C)	t.ber. (°C)	aantal polig (-polig)	functie	SC (A)	voeler ø (mm)	voeler L (mm)	cap. (mm)	capillaire pijp geïsoleerd (mm)	stopbus	as L (mm)	passend voor	fabrikantnr.
3	9690.2249	320	50-320	1	1NO	16	3,03	160	3150	-	-	23	EGO EGO EGO	55.13069.010 55.13069.040 55.13069.540
3	9690.2289	324	54-324	1	1NO	16	3,03	147	1270	1180	-	23	EGO Küppersbusch	55.13069.140 161614
3	9690.2353	358	50-358	1	1NO	16	3,1	147	1730	1100	-	23	EGO Malag Ubert	55.13072.010 55.13075.010 143702 342229
3	9690.2279	400	100-400	1	1NO	16	3,9	163	830	-	-	23	Bartscher EGO RSI VEGA	029154 55.13072.130 30008101 93044 G
3	9690.2324	440	vast 440	1	1NO	16	3,9	228	1130	850	-	-	EGO Küppersbusch	55.13183.020 161624
4	9690.4285	91	29-91	1	1CO	15	6	113	1470	-	-	-	EGO Electrolux Zanussi	55.13214.340 049243 049243
4	9690.4286	109		1	1CO	16	3,03	198	900	610	M9x1	-	EGO Inxtrend Lotus Whirlpool	55.13322.100 C2218-00 RRC2218-00 483286008707
4	9105.0665	110	27-110	1	1NO	16	6	113	520	350	-	-	Bonamat EGO	6.016.005.018 55.13029.100
4	9690.2311	132	vast 132	1	1CO	16	6	86	1150	350	-	-	EGO Malag	55.13323.010 105767
5	9690.4287	110	30-110	1	1NC	16	6	115	830	-	-	23	Bartscher EGO	A02030935 55.13022.050
6	9690.4288	114	36-114	1	1NO	16	31/36	-	870	800	-	23	EGO MKN	55.13022.450 203167
7	9625.1285	291	50-291	1	1NO	16	3	160	980	600	-	25	EGO Falcon	55.13059.180 731910500

														
8	9690.4290	332	70-332	1	1NO	16	3	160	1470	-	-	26	EGO	55.13064.180





serie 55.14\_

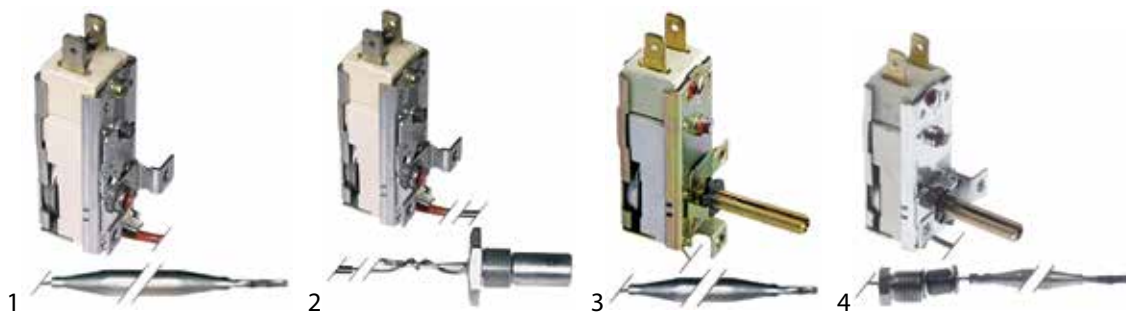

afb.	bestelnr.	t.max. (°C)	t.ber. (°C)	aantal polig (-polig)	functie	SC (A)	voeler ø (mm)	voeler L (mm)	cap. (mm)	capillaire pijp geïsoleerd (mm)	stopbus	as L (mm)	aspositie	passend voor	fabrikantnr.
1	9690.4291	53	vast 53	1	1NC	16	6	116	600	600	-	-	-	EGO Elettrobar	55.14119.849 236024
2	9162.3558	58	vast 58	1	1NC	16	11	35	580	580	-	-	-	Bartscher Colged EGO GIGA Palux	0236023 DRT130B 55.14119.850 D236023 349305
3	39565.0140	83	30-83	1	1NO	16	6	113	1480	700	-	25	boven	Blanco EGO	105795 55.14014.030
3	9995.0265	95	30-95	1	1NO	10	6	113	1480	700	-	25	boven	Blanco EGO	105796 55.14014.040
3	9690.4292	117	30-117	1	1NO	16	3,03	178	990	-	-	23	-	EGO	55.14029.090
3	9690.4293	130	30-130	1	1NO	16	6	83	880	-	-	25	boven	Blanco EGO	105797 55.14022.120
3	9690.4294	140	30-140	1	1NO	16	3	156	900	900	-	23	links	CPE EGO	55.14022.800 55.14022.800
4	9690.1125	90	30-90	1	1NO	16	6	74	900	800	M10x1	23	-	Baron Cookmax EGO Mareno Silko	MA1037117700 1037117700 55.14012.800 MA1037117700 MA1037117700
4	9690.4295	128	35-128	1	1NO	16	3,1	174	880	800	-	23	onder	EGO	55.14022.100

serie 55.17\_



afb.	bestelnr.	t.max. (°C)	t.ber. (°C)	aantal polig (-polig)	functie	SC (A)	voeler ø (mm)	voeler L (mm)	cap. (mm)	capillaire pijp geïsoleerd (mm)	stopbus	as L (mm)	aspositie	passend voor	fabrikantnr.
1	9690.4296	85	30-85	1	1NO	16	6	94	840	-	-	23	boven	EGO Inoksan	55.17012.010 10100003
1	9690.3097	110	30-110	1	1NO	16	6	83	840	-	-	23	boven	EGO	55.17022.030
1	9690.4297	184	70-184	1	1CO	16	6	87	490	250	-	23	boven	Acopa Amitek EGO	10010 R00041 55.17039.030
1	9690.4298	190	130-190	1	1NO	16	6	115	1300	-	-	23	-	EGO EGO	55.17039.010 55.17039.040
1	9690.4299	250	50-250	1	1NO	16	3,03	178	840	-	-	23	boven	EGO Fiamma	55.17042.060 4.0.066.0114

Tabel wordt vervolgd op de volgende pagina

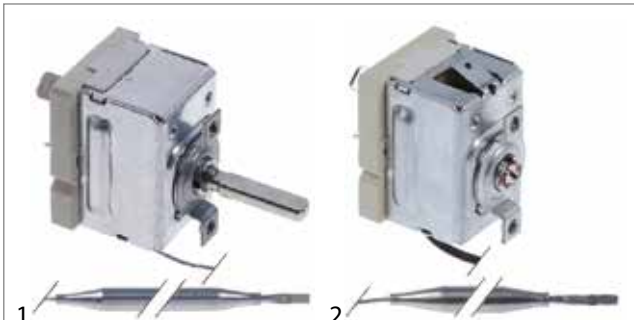
afb.	bestelnr.	t.max. (°C)	t.ber. (°C)	aantal polig (-polig)	functie	SC (A)	voeler ø (mm)	voeler L (mm)	cap. (mm)	capillaire pijp geïsoleerd (mm)	stopbus	as L (mm)	aspositie	passend voor	fabrikantnr.
1	9162.5120	282	96-282	1	1NO	16	3,03	196	1240	350	-	22	links	EGO Electrolux Zanussi	55.17053.040 005207 005207
1	9690.4300	287	57-287	1	1NO	16	3,1	122	1100	1050	-	23,5	rechts	EGO Garbin	55.17059.150 TER005
1	9690.4301	295	62-295	1	1CO	16	3,03	152	1060	960	-	23	-	EGO Smeg	55.17059.310 818731124
1	9690.4302	310	50-310	1	1NO	16	4	111	1000	-	-	16	-	EGO GMG	55.17069.120 KL-010
1	9287.0400	320	50-320	1	1NO	16	3,03	178	840	-	-	23	boven	EGO Inoksan Rosinox	55.17062.140 10100004 RX94804655
2	9342.1080	85	vast 85	1	1CO	16	6	115	1500	1420	-	-	-	Adler EGO Electrolux	20596 55.17314.020 070350

## serie 55.18\_



pos.	bestelnr.	t.max. (°C)	t.ber. (°C)	aantal polig (-polig)	functie	SC (A)	voeler ø (mm)	voeler L (mm)	cap. (mm)	capillaire pijp geïsoleerd (mm)	stopbus	as L (mm)	passend voor	fabrikantnr.
1	9690.4303	85	35-85	1	1NO	16	6	113	2020	500	-	15	Blanco EGO	105899 55.18019.130
2	9690.2485	95	34-95	1	1NO	16	6	113	1470	-	-	25	Blanco EGO	359583 55.18014.020
3	9690.4304	110	9-110	1	1NO	16	6	94	870	-	-	15	EGO	55.18022.060
4	9690.4305	116	35-116	1	1NO	16	6	113	1770	500	-	15	Blanco EGO	105883 55.18025.010
5	9690.4306	120	32-110	1	1NO	16	6	110	870	-	M9x1	25	EGO Falcon Lincat	55.18022.010 539113130 TH34
6	9690.4307	130	35-130	1	1NO	16	6	113	900	500	-	17	Blanco EGO	105900 55.18022.040
7	9690.4308	190	121-190	1	1NC	16	6	117	390	-	-	15	Bartscher EGO Olis	A010502 55.18031.010 6A010502

Tabel wordt vervolgd op de volgende pagina



pos.	bestelnr.	t.max. (°C)	t.ber. (°C)	aantal polig (-polig)	functie	SC (A)	voeler ø (mm)	voeler L (mm)	cap. (mm)	capillaire pijp geïsoleerd (mm)	stopbus	as L (mm)	passend voor	fabrikantnr.
8	9690.4309	190	130-190	1	1NO	16	6	113	870	-	M9x1	25	EGO Falcon Falcon Lincat	55.18032.040 731300190 731320106 TH59
9	9690.4379	190	130-190	1	1NO	16	6	118	890	-	-	23	Corsair EGO Lincat Parry Valentine	42-045 55.18032.020 TH69 — —
10	9690.4379	190	130-190	1	NO	16	6	119	400	190	-	23	EGO Lincat	55.18031.040 TH82
11	9690.4310	320	50-320	1	NO	16	3	158	870	-	-	23	Ascobloc EGO Lincat Parry	09/1687 55.18062.050 TH12 —

serie 55.22\_

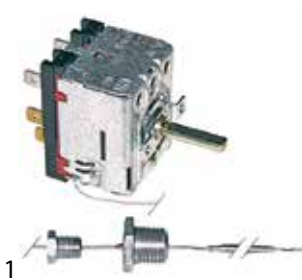

afb.	bestelnr.	t.max. (°C)	t.ber. (°C)	aantal polig (-polig)	functie	SC (A)	voeler ø (mm)	voeler L (mm)	cap. (mm)	capillaire pijp geïsoleerd (mm)	stopbus	as L (mm)	passend voor	fabrikantnr.
1	9690.2196	102	30-90 / 50-102	2	2CO	16	3,1	334	1440	1400	-	23	EGO Electrolux Juno	55.22214.010 0H6242 0H6242

serie 55.34\_

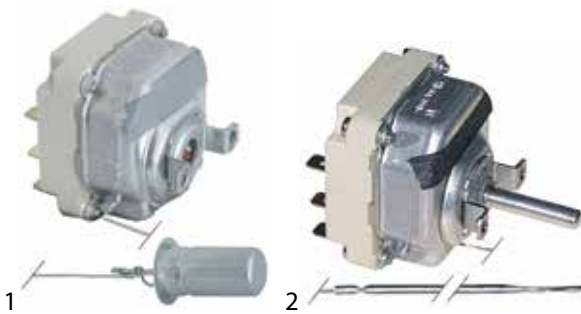

afb.	bestelnr.	t.max. (°C)	t.ber. (°C)	aantal polig (-polig)	functie	SC (A)	voeler ø (mm)	voeler L (mm)	cap. (mm)	capillaire pijp geïsoleerd (mm)	stopbus	as L (mm)	passend voor	fabrikantnr.
1	AAW451000	52	vast 45/52	2	2CO	16	15	22,5	2280	-	-	-	EGO Krefft	55.34319.050 602959
2	9010.0760	85	15-60/15-85	2	2CO	16	6	113	2980	300/300	-	23	EGO Krefft	55.34216.030 602715
2	9690.4311	85	30-85	3	3NO	16	6	131	1440	-	M9x1	23	Capic EGO Stahl Thielmann Ubert	E401011 55.34014.150 162015 144180 342217
2	9690.2346	85	35-85	3	3CO	16	9,5	80	870	-	-	23	EGO Elframo Komel	55.34212.828 22190001 22190001
2	9162.8008	90	38-90	3	3CO	16	6	215	900	900	-	-	EGO Electrolux Lasa Mareno Zanussi	55.34212.801 049191 3267240 1037304900 049191
2	9705.1470	93	30-93	2	2NO	16	6	173	1780	-	M9x1	23	EGO	55.34015.010
2	9690.2223	93	30-93	3	3CO	16	6	175	870	-	M9x1	23	EGO	55.34212.030
2	9191.0325	93	30-93	3	3CO	16	6	235	880	700	M9x1	23	EGO Palux	55.34212.090 006955

Tabel wordt vervolgd op de volgende pagina

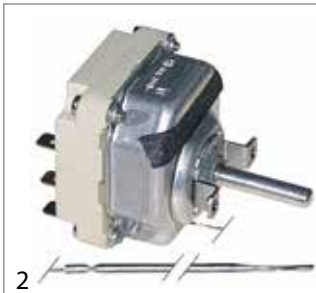

afb.	bestelnr.	t.max. (°C)	t.ber. (°C)	aantal polig (-polig)	functie	SC (A)	voeler ø (mm)	voeler L (mm)	cap. (mm)	capillaire pijp geïsoleerd (mm)	stopbus	as L (mm)	passend voor	fabrikantnr.
2	9162.1630	93	30-93	3	3NO	16	6	129	1480	1100	M10x1	23	Angelo-Po EGO EGO EGO EGO Electrolux Foem Gico Juno Lotus Mareno MBM-Italia Olis Sagi Silko Zanussi	32z0130 55.34012.801 55.34012.859 55.34014.190 55.34019.805 6301018190 052000 05000087250 53403003090 052000 537000800 MA1037035015 160561 BN6A046250 32Z0130 MA1037035015 052000
2	9690.4314	110	30-110	3	3NO	16	6	130	1200	1200	-	23	EGO	55.34023.801
2	9690.4315	110	30-110	3	3NO	16	6	131	1160	-	-	23	EGO EGO Malag Mareno	55.34023.050 55.34024.805 105813 CR0500540
2	9690.4316	110	30-110	3	3NO	16	6	131	900	-	M9x1	23	EGO Techninox	55.34022.802 RC00001207
2	9690.0025	110	30-110	3	3NO	16	6	131	1200	600	-	23	EGO Electrolux Zanussi	55.34023.815 0A2237 0A2237
2	9690.4313	110	1x20-90/2x40-110	3	2NO/1NO	16	6	130	900	900	-	23	EGO Olis	55.34022.809 BN6A046240
2	9690.1185	110	32-110	3	3CO	16	6	138	2980	2200	M9x1	23	EGO EGO Emmepi MKN Palux Repagas Rosinox Silko Stierlen	55.34029.080 55.34226.040 808058 203486 291706 22405003 RX94805421 SIR0108112 02100304
2	9610.0215	110	32-110	3	3NO	16	6	138	1480	1100	M9x1	23	Alpeninox Ambach Blumauer Bonnet Capic CoffeeQueen EGO EGO EGO EGO EGO Electrolux Gastrofrit Haka Juno King Lotus MKN Modular Morice Palux Scholl Silko Solymac Stahl Techninox Zanussi	0A2237 5061608152 180705 7492058 E401015 160215 55.34022.130 55.34022.160 55.34022.810 55.34024.060 55.34025.060 004911 306025.007 9041 004911 004911 537012300 203491 66100500 TH1084 290319 70,10,05 SIR0101388 P76 162020 RC00274000 004911

Tabel wordt vervolgd op de volgende pagina



afb.	bestelnr.	t.max. (°C)	t.ber. (°C)	aantal polig (-polig)	functie	SC (A)	voeler ø (mm)	voeler L (mm)	cap. (mm)	capillaire pijp geïsoleerd (mm)	stopbus	as L (mm)	passend voor	fabrikantnr.
2	9690.4758	120	45-120	3	3CO	16	6	140	900	870	-	23	Baron EGO Giorik Lincar	BN4185326010016 55.34222.807 6010016 40000908
2	9690.4317	125	65-125	3	3NO	16	6	77	880	880	-	23	Baron Cookmax EGO Olis	BN6A044650 6A044650 55.34022.813 BN6A044650
2	9690.4318	129	34-129	3	3NO	16	6	140	2260	120	-	23	EGO Öztiryakiler	55.34029.010 6234.00001.37
2	NML	175	100-175	3	3NO	16	4	157	850	350	-	23	EGO FriFri Tecnoinox	55.34039.080 400369 RC00064000
2	9690.4320	175	100-175	3	3NO	16	6	131	2000	600	-	23	EGO Electrolux	55.34039.837 0A2003
2	9123.0065	180	100-180	3	3NO	16	6	131	2000	1800	-	23	Bartscher Bertos Bonnet Cookmax EGO Mareno Olis	023964 33066200 301062 8219601 55.34039.800 BN8219601 BN8219601
2	9123.0064	180	100-180	3	3NO	16	6	133	2300	450	M9x1	23	EGO Imperial-Germany MKN	55.34039.030 8018402 203661
2	9690.0068	180	90-180	3	3CO	16	6	133	880	800	-	23	EGO Electrolux	55.34232.010 0K9907
2	9690.0500	180	95-180	3	3NO	16	6	133	1780	1400	M9x1	23	Ambach Bonnet EGO EGO EGO Electrolux GIGA Haka Juno MKN Scholl Therma Thirotde Ubert	5061608750 301062 55.34032.813 55.34034.150 55.34035.080 0H6127 AEC002ZR10 9042 0H6127 203497 70,10,04 0H6127 301062 342206
2	9610.0040	180	95-180	3	3NO	16	6	133	1780	1400	M10x1	23	EGO EGO EKU Emmepi Foem Mareno	55.34032.390 55.34035.130 4-103 807603 05050033650 MA1037101400
2	9690.0038	180	99-180	3	3NO	16	7	175	880	-	-	23	EGO	55.34032.320
2	9162.9560	185	100-185		3NO	16	4	231	2600	1000	-	23	EGO Electrolux Tecnoinox	55.34039.807 004925 RC00281000
2	9162.1510	185	60-185	3	3NC	16	4	229	2600	1000	-	23	EGO Electrolux Zanussi	55.34039.856 051361 051361
2	9690.4759	185	60-185	3	3NO		3	235	1180	1060	M9x1	24	EGO Electrolux	55.34033.020 0G2760
2	9162.2205	185	60-185	3	3NO	16	4	229	1200	1150	-	23	EGO Electrolux	55.34033.801 005940
2	9191.0034	185	95-185	3	3NO	16	6	117	1480	800	-	23	EGO Palux	55.34034.010 178144
2	9023.0180	185	95-185	3	3NO	16	6	133	2430	1100	M9x1	23	EGO EGO FriFri MKN Roka	55.34034.110 55.34039.020 400370 203487 8900210
2	9998.5586	188	95-188	3	3NO	16	6	117	1780	1400	-	23	EGO Küppersbusch Thielmann	55.34035.110 540444 143766
2	9690.4760	190	100-190	3	3NO	16	6	133	530	500	-	23	Gastrofrit	306025.006
2	9690.4761	190	100-190	3	3NO	16	6	133	530	500	-	23	EGO	55.34039.100
2	9690.2323	190	106-190	3	1CO/2NO	16	4	157	1780	1500	-	23	EGO Valentine	55.34235.040 6310-SA

Tabel wordt vervolgd op de volgende pagina



2

afb.	bestelnr.	t.max. (°C)	t.ber. (°C)	aantal polig (-polig)	functie	SC (A)	voeler ø (mm)	voeler L (mm)	cap. (mm)	capillaire pijp geïsoleerd (mm)	stopbus	as L (mm)	passend voor	fabrikantnr.
2	9690.2321	190	120-190	3	1CO/2NO	16	6	133	880	350	-	23	EGO Electrolux Therma Valentine	55.30032.030 55.34232.030 002587 002587 3201-02
2	9690.4323	190	130-190	3	3NO	16	6	219	880	-	-	23	EGO Falcon Lincat	55.34032.300 539215840 TH24
2	9690.1110	190	56-190	3	3NO	16	6	130	900	670	M10x1	23	EGO Emmepi Giorik	55.34032.863 807603 6010004
2	9690.2415	190	95-190	3	3NO	16	6	133	1480	-	-	23	EGO Electrolux Parry	55.34034.170 0K3092 nml —
2	ABJ083400	191	68-191	3	3NO	16	6	79	840	-	M9x1	23	Capic EGO Hobart Morice Roller-Grill Rosinox Solymac	— 55.34032.060 49360008 TH1079 A06005 RX24845588 P77A
2	9475.0004	192	100-192	3	3NO	16	7	200	870	-	-	23	EGO Elframo Komel	55.34032.800 22160001 22160001
2	9025.0735	195	95-195	3	3NO	16	6	117	1780	1400	M9x1	23	Bertos EGO EGO EGO GIGA Krefftt Küppersbusch MKN Modular Nayati Rosinox Silko Star10	22062900 55.34034.801 55.34035.010 55.34035.090 X43800 49-355637 355637 203497 66104100 GS2228 RX94804978 SIR0109055 X43800
2	9998.0565	200	60-200	3	3NO	16	3,1	235	1480	-	-	23	EGO FriFri	55.34034.210 100374
2	9690.0012	200	60-200	3	3NO	16	6	77	880	-	-	23	EGO	55.34032.030
2	9690.0036	200	60-200	3	3NO	16	6	142	880	-	-	23	EGO	55.34032.010
2	9690.4324	200	68-200	3	3NO	16	6	77	880	800	M9x1	23	Capic EGO EGO EGO Electrolux FriFri Juno Morice	E401045 55.34032.160 55.34032.430 97.55340.423 0H6221 09580111 0H6221 TH1079
2	9690.4762	200	68-200	3	3NO	16	6	79	2390	1600	M9x1	23	EGO Rosinox	55.34039.050 RX94016698
2	9690.2320	206	120-206	3	1CO/2NO	16	4	157	1780	1500	-	23	EGO Electrolux Therma Valentine	55.34235.020 0KL450 0KW841 6311-SA
2	9835.0385	210	95-210	3	3NO	16	3,1	226	1780	1600	-	23	Ascobloc EGO Küppersbusch	8152105 55.34035.100 152105
2	9690.2465	220	60-220	3	3NO	16	6	77	880	-	-	23	EGO	55.34032.110
2	9690.4325	220	95-220	3	3NO	16	6	117	1480	1100	-	23	EGO MKN	55.34044.020 203499

Tabel wordt vervolgd op de volgende pagina



afb.	bestelnr.	t.max. (°C)	t.ber. (°C)	aantal polig (-polig)	functie	SC (A)	voeler ø (mm)	voeler L (mm)	cap. (mm)	capillaire pijp geïsoleerd (mm)	stopbus	as L (mm)	passend voor	fabrikantnr.
2	9163.0570	230	95-230	3	3NO	16	4	128	1250	1000	-	23	EGO Electrolux Mareno Modular Silko Zanussi	55.34043.800 0C7528 CR0686120 66112300 CR0686120 002402
2	9690.0950	240	55-240	3	3NO	16	4	91	880	350	-		EGO Silko	55.34042.805 SIR0101424
2	9690.4326	250	48-250	3	3NO	16	3,1	226	880	850	-	23	EGO Roka	55.34042.170 8900211
2	9690.2331	260	100-260	3	3NO	16	6	75	1150	1150	-	23	EGO	55.34059.807
2	NML	270	0-270	3	3NO	-	6	75	2400	-	-	23	Bourgeois EGO	THER017 55.34059.090
2	9690.2217	270	55-270	3	3NO	16	3	219	900	900	-	23	EGO Gico	55.34052.831 53403050390
2	9690.4327	275	50-275	3	3NO	16	3	219	900	900	-	23	Casta EGO Olis	08/85900009 55.34052.809 BN6A044601
2	9690.4328	278	71-278	3	3NO	16	6	75	1180	1100	-	23	Bertos EGO	30064900 55.34059.814
2	9162.3936	285	100-285	3	3NO	16	3	219	1150	1130	-	23	EGO Electrolux MBM-Italia Zanussi	55.34059.801 059235 164332 059235
2	9690.4330	295	75-295	3	3NO	16	4	92	900	350	-	23	EGO Rosinox Silko	55.34052.811 RX94812621 SIR0101373
2	9162.0503	298	50-298	3	3NO	16	3	219	900	-	-	23	EGO Electrolux Mareno Tecnoinox	55.34052.817 004917 MA1037100600 RC00285000
2	9690.1145	300	50-300	3	3CO	16	6	77	2980	2260	-	23	EGO EGO MKN	55.34059.060 55.34256.020 203488
2	9033.0335	300	50-300	3	3NO	16	3	219	900	-	-	23	Baron Cookmax EGO EGO Lincar Mareno Modular Rosinox Silko	MA1309115 1309115 55.34052.815 55.34052.819 40000905 MA1309115 66102700 RX94805645 MA1309115
2	9690.2243	300	50-300	3	3NO	16	3	219	900	900	-	23	EGO MBM-Italia	55.34052.812 RTCU600067
2	9690.0465	300	50-300	3	3NO	16	3	219	900	900	-	23	Baron Cookmax EGO Gico	41826630123 41826630123 55.34052.807 53403000350
2	9690.2304	300	50-300	3	3NO	16	3,1	226	1180	500	-	23	EGO Malag	55.34053.050 105784
2	9000.0475	300	50-300	3	3NO	16	4	229	900	900	-	23	Ambach EGO	5061618784 55.34062.826
2	9998.0345	300	50-300	3	3NO	16	4	292	1440	-	-	23	EGO	55.34054.060
2	9690.1030	300	50-300	3	3NO	16	4	292	880	800	-	23	EGO MKN Palux	55.34052.060 203565 723231

Tabel wordt vervolgd op de volgende pagina



2

afb.	bestelnr.	t.max. (°C)	t.ber. (°C)	aantal polig (-polig)	functie	SC (A)	voeler ø (mm)	voeler L (mm)	cap. (mm)	capillaire pijp geïsoleerd (mm)	stopbus	as L (mm)	passend voor	fabrikantnr.
2	9690.0960	300	50-300	3	3NO	16	6	79	1740	800	-	23	Angelo-Po Anitec Ascobloc Bertos Blumauer Bonnet Bourgeois Capic EGO EGO EGO EGO Electrolux GIGA Haka Imperial-Germany Juno King Miele MKN Morice Öztiryakiler Repagas Rosinox Solymac Star10 Therma Thielmann Zanussi	32Z2560 X43900 09/3458 22062600 183305 301005 THER007 E401060 55.34052.270 55.34054.050 55.34055.020 55.34059.804 0H6217 X43900 9044 18882 0H6217 0H6217 08018882 203494 TH1086 6234.00001.14 32104009 RX94032588 P79 X43900 0H6217 139783 0H6217
2	9690.2285	300	60-300	3	3NO	16	3,1	263	1180	800	-	23	EGO Electrolux Juno	55.34053.030 0H6218 0H6218
2	9690.0395	300	60-300	3	3NO	16	4	128	880	800	-	23	EGO Palux	55.34052.020 224081
2	9162.2540	300	115-300	3	3NO	10	3	144	1150	1130	-	23	EGO Electrolux	55.34059.812 004363
2	9690.2256	308	100-300	3	3NO	16	6	75	1150	-	-	23	EGO	55.34059.806
2	9690.2252	320	110-320	3	3NO	16	6	96	1780	1600	-	23	EGO Electrolux Juno	55.34065.020 0H6216 0H6216
2	9690.2290	320	50-320	3	3NO	16	3	219	1200	1200	-	23	EGO Electrolux Lotus Therma	55.34063.811 0K8421 537000900 0K8421
2	9162.0016	320	50-320	3	3NO	16	3,1	226	1480	1400	-	23	Alpeninox EGO Electrolux Foem Gico Juno Lotus Mareno Olis Silko Zanussi	0A2206 55.34064.030 0A2206 05000087350 53403050300 0A2206 537013500 1732000 BN6A044600 0101384 0A2206
2	9690.2245	320	55-320	3	3NO	10	4	128	900	-	-	23	EGO Giorik Ilsa Offcar	55.34062.819 5910028 843735 843735
2	9162.1648	320	60-320	3	3NO	16	4	128	1800	1300	-	23	EGO Electrolux Inoksan	55.34069.804 052099 10100005
2	9283.0130	330	100-330	3	3NO	16	6	75	870	870	-	23	EGO Modular	55.34062.803 66100700

Tabel wordt vervolgd op de volgende pagina





afb.	bestelnr.	t.max. (°C)	t.ber. (°C)	aantal polig (-polig)	functie	SC (A)	voeler ø (mm)	voeler L (mm)	cap. (mm)	capillaire pijp geïsoleerd (mm)	stopbus	as L (mm)	passend voor	fabrikantnr.
3														
4														
5														
6														
2	9690.4329	350	100-350	3	3NO	-	3	147	900	-	-	26	Baron EGO Mareno Modular Silko	CR0582770 55.34062.160 CR0582770 66111600 CR0582770
2	9690.0234	350	100-350	3	3NO	16	6	75	870	-	-	23	EGO Lincat Olis	55.34062.010 TH39 6A044900
2	9690.0470	350	100-350	3	3NO	16	6	77	2430	1100	-	23	Bonnet Charvet EGO EGO EGO EGO MKN Morice Palux Solymac Thirode	7471044 01999a 55.34062.030 55.34064.010 55.34065.010 55.34069.030 203406 TH1088 291730 P80 301006
2	9690.2198	350	60-350	3	3NO	16	4	128	880	800	-	23	EGO Electrolux	55.34062.150 293586
2	9162.0895	350	vast 350	3	3NC	16	3	190	900	900	-	-	EGO Electrolux Zanussi	55.34162.800 0C0270 0C0270
2	9690.1105	360	140-360	3	3NO	16	4	292	990	500	-	23	EGO Eloma Malag Palux	55.34079.050 ELE334008 105849 126543
2	9690.2215	400	91-400	3	3NO	16	3,9	308	920	800	-	23	EGO Malag	55.34079.010 105847
2	9690.2192	470	50-470	3	3NO	16	3,9	308	990	800	-	23	EGO Fage Inoksan	55.34089.010 EGO500 10100002
2	9095.0026	500	50-500	3	3NO	16	4	228	1200	-	-	23	EGO Fage GGF	55.34093.800 EGO500 thermo003
2	9690.4331	512	60-512	3	3NO	16	3,8	225	1150	1110	-	32	EGO GGF Moretti	55.34083.803 TERMO002 74200140
3	9162.0170	90	30-90	3	3CO	16	6	215	900	-	-	-	Bonnet EGO Electrolux Juno Morice Therma	5004E 55.34212.814 OKI260 OKI260 DE1237 OKI260
3	9162.0016	90	vast 55/90	2	2CO	16	6	175	360	210	-	-	EGO Palux	55.34311.020 277096
3	9220.0989	120	vast 120	2	2CO	16	3,1	305	720	600	-	-	EGO Küppersbusch Palux	55.34329.040 540525 136840
4	9385.0105	116	29-116	1	1NO	16	6	241	400	-	-	23	EGO	55.34021.020
5	9690.4588	120	30-120	3	3NO	16	11	28	900	900	-	23	Ambach EGO	5061603938 55.34022.829
5	9980.0035	185	80-185	3	3NO	16	11	28	900	700	-	23	Ambach EGO EGO	5061603922 55.34032.834 55.34032.839
6	9162.3246	160	66-160	3	3NO	16	8	115	800	-	-	23	EGO Electrolux Morice	55.34039.811 026860 TH1084

7

afb.	bestelnr.	t.max. (°C)	t.ber. (°C)	aantal polig (-polig)	functie	SC (A)	voeler ø (mm)	voeler L (mm)	cap. (mm)	capillaire pijp geïsoleerd (mm)	stopbus	as L (mm)	passend voor	fabrikantnr.
7	9690.2337	490	70-490	3	3NO	16	3,9	380	1180	960	-	25	EGO Wamsler	55.34083.050 011170067

## serie 55.35\_



1

afb.	bestelnr.	t.max. (°C)	t.ber. (°C)	aantal polig (-polig)	functie	SC (A)	voeler ø (mm)	voeler L (mm)	cap. (mm)	capillaire pijp geïsoleerd (mm)	stopbus	as L (mm)	passend voor	fabrikantnr.
1	NML	250	105-250	2	2CO	16	3	146	1500	800	-	23	EGO Electrolux Juno	55.35254.010 0H6223 0H6223

## serie 55.40\_



1

afb.	bestelnr.	t.max. (°C)	t.ber. (°C)	aantal polig (-polig)	functie	SC (A)	voeler ø (mm)	voeler L (mm)	cap. (mm)	capillaire pijp geïsoleerd (mm)	stopbus	as L (mm)	passend voor	fabrikantnr.
1	NML	90	30-82 / 38-90	4	1CO/3CO	16	6	215	880	800	-	23	EGO Electrolux Therma Zanussi	55.40212.030 046413 046413 046413
1	9690.2297	300	60-204°C/135-300	4	2NO/2NO	16	4	128	880	800	-	23	EGO Küppersbusch Palux	55.40052.070 540568 634980
1	9690.2197	450	100-450	4	4NO	16	3,9	163	1180	850	-	23	Ascobloc EGO EKU MKN	093305 55.40083.010 4-116 203407



serie 55.60\_

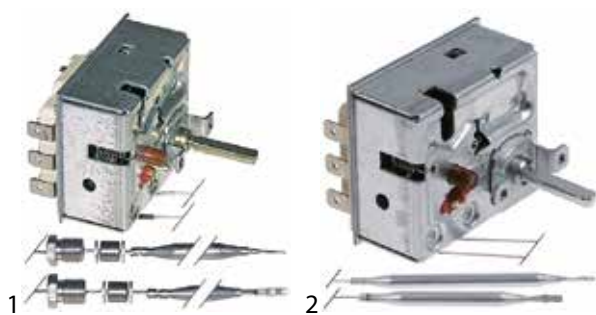

afb.	bestelnr.	t.max. (°C)	t.ber. (°C)	aantal polig (-polig)	functie	SC (A)	voeler ø (mm)	voeler L (mm)	cap. (mm)	capillaire pijp geïsoleerd (mm)	stopbus	as L (mm)	passend voor	fabrikantnr.
1	9998.0435	180	135-180	3	3NC/3NO	16	6	167/87	1770	-	M9x1	23	EGO Ubert	55.60035.010 342213
2	9690.4332	195	53-195	3	3NC/3NO	16	6	107/87	1470	-	-	23	EGO	55.60034.010
2	9690.4333	270	120-270	3	3NC/3NO	16	6	100/80	870	770	-	23	EGO	55.60052.020
2	9690.4334	120/130		3	3NC/3NO	-	6	85/100	870	870	-	-	EGO	55.60012.530

maximaal thermostaten

serie 51\_



afb.	bestelnr.	T.uit (°C)	aantal polig (-polig)	SC (A)	voeler ø (mm)	voeler L (mm)	cap. (mm)	capillaire pijp geïsoleerd (mm)	stopbus	voeler	passend voor	fabrikantnr.
1	NML	229	1	0,5	6	142	830	-	M9x1	RVS	EGO Electrolux Juno Mareno	51.32915.070 0H6139 0H6139 MA1031028000
2	NML	365	2	16	4	116	1170	1100	-	-	EGO Krefft Rational	51.64945.020 76-30140322 3014.0322
3	9406.0890	365	2	16	4	120	1170	1100	-	RVS	EGO Krefft Küppersbusch Rational Rosinox	51.64945.010 76-30140310 407275 3014.0310 RX24848111



## serie 55.10/19\_



afb.	bestelnr.	T.uit (°C)	aantal polig (-polig)	SC (A)	voeler ø (mm)	voeler L (mm)	cap. (mm)	capillaire pijp geïsoleerd (mm)	stopbus	voeler	passend voor	fabrikantnr.
1	9690.2272	107	1	16	6	77	1170	1150	-	-	EGO Elframo Komel	55.19523.010 22180100 22180100
1	9690.2500	125	1	16	6	77	870	700	-	-	EGO Mach	55.19522.040 500064000
1	9690.4336	140	1	16	6	74	900	900	-	-	Cookmax EGO Electrolux Silko	41826630240 55.19522.050 056745 SIR0101394
1	ALA130015	145	1	16	6	130	900	900	-	RVS	EGO EGO Gico Lainox	55.10522.801 55.19522.060 6340004014500 LAR65070080
1	9690.4337	154	1	16	3	227	900	850	-	-	Ambach EGO	5061600808 55.19522.080
1	9690.4338	200	1	0,5	6	130	900	900	-	-	EGO EGO Olis	55.10542.808 55.19532.010 BN9000217
1	9162.2888	220	1	0,5	3	174	800	-	-	RVS	EGO EGO	55.10549.811 55.19549.040
1	9610.0260	220	1	0,5	6	140	900	-	-	M9x1	Cookmax EGO EGO EGO Heidebrenner Mareno Olis	6A049401 55.10542.814 55.10542.841 55.19542.010 94306 MA732913 BN6A049401
1	9690.2349	220	1	15	6	77	870	-	-	RVS	EGO EGO Electrolux Multi	55.10542.831 55.19542.200 0780057347 661021
1	9690.4340	220	1	16	6	142	2970	2600	-	RVS	EGO EGO Mareno	55.10546.840 55.19546.010 MA1568700
1	9690.2248	224	1	0,5	6	133	870	-	M10x1	-	EGO	55.19542.040
1	9690.4608	225	1		6	86	2020	1770	-	RVS	EGO Gico	55.19549.030 53400112220
1	9998.3035	225	1	0,5	6	133	870	-	M10x1	-	EGO EGO Emmepi Giorik Mareno MBM-Italia Olis VEGA	55.10542.830 55.19542.020 808181 6010020 MA732913 RTBF900094 BN6A049401 93239G
1	9023.0045	230	1	16	6	133	870	700	-	RVS	Baron EGO Olis	BN41826630390 55.19542.110 BN9000515
1	9283.0004	235	1	0,5	6	130	1800	1500	M9x1	RVS	Alpeninox Bertos EGO EGO Electrolux GIGA Ilsa Modular Silko Star10 Zanussi	0A2011 32070200 55.10545.800 55.19545.010 0A2011 X49500 R_60986 66102100 SIR0109056 Y16300 0A2011
1	9610.0355	235	1	16	6	133	870	830	-	RVS	Bonnet EGO EGO Lotus	5519542090 55.10542.842 55.19542.090 537001300

Tabel wordt vervolgd op de volgende pagina

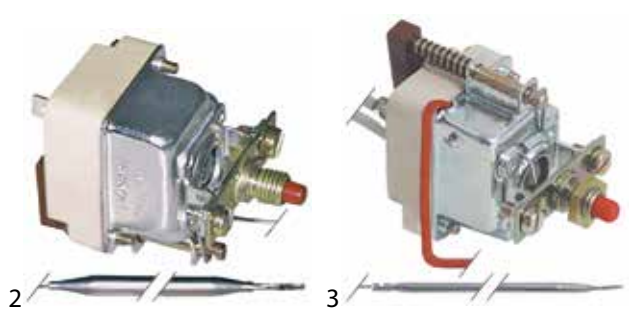
afb.	bestelnr.	T.uit (°C)	aantal polig (-polig)	SC (A)	voeler ø (mm)	voeler L (mm)	cap. (mm)	capillaire pijp geïsoleerd (mm)	stopbus	voeler	passend voor	fabrikantnr.
1	9025.0180	245	1	16	6	130	1200	1200	-	-	EGO EGO GIGA Rosinox Silko Star10	55.10543.802 55.19543.010 X49500 RX94804986 SIR0109056 X49500
1	9690.2235	250	1	16	6	87	1470	1460	-	RVS	EGO OEM	55.19544.020 ED04900
1	9690.4763	300	1	16	6	74	900	700	-	-	EGO EGO Emmepi	55.10552.806 55.19552.020 C00546
1	ABJ081900	327	1	16	6	77	870	-	-	RVS	EGO EGO Olis Silko	55.10562.830 55.19562.020 BN6A049500 SIR0101387
1	9690.4339	350	1	16	6	74	900	-	-	RVS	EGO EGO Ilsa Olis	55.10562.828 55.19562.010 60761 BN6A046170
1	NML	352	1	16	3	200	885	780	-	-	EGO	55.19562.120
1	9690.2296	360	1	0,5	3,1	201	900	870	-	RVS	EGO MBM-Italia	55.19572.020 RTBF800076
1	9690.4764	360	1	16	4	128	1170	990	-	-	EGO Tecnoinox	55.19573.010 RC00770000
1	9690.4341	360	1	16	6	77	870	660	M10x1	-	EGO Giorik Lincar MBM-Italia	55.19562.030 6010026 40000914 RTFOC00483
1	9690.4343	512	1	16	3,9	228	1470	960	-	RVS	EGO Moretti	55.19584.010 74200370
2	9690.2219	130	1	16	6	129	870	-	-	RVS	Bertos EGO EGO EGO Electrolux Ilsa Tecnoinox	25070000 55.10522.020 55.10522.802 55.19522.020 004912 34440 RC00427000
2	9690.1100	224	1	0,5	6	133	870	-	M10x1	-	Baron EGO Emmepi Giorik Offcar Rosinox Silko	85322001046 55.10542.853 808181 2011140 862133 RX94805702 SIR0108038
2	9690.0615	230	1	0,5	6	77	870	-	-	RVS	EGO EGO EGO Electrolux Foem Tecnoinox	55.10542.805 55.19542.130 55.32542.823 004951 05750107250 RC00450000
3	9475.0200	230	1	0,5	4	116	1500	-	-	RVS	EGO Elframo GIGA Komet	55.19544.010 22170001 X56700 22170001
3	9690.4344	230	1	0,5	4	125	1550	1410	-	-	EGO Elframo Repagas	55.19549.050 22170003 09500064
3	9690.4345	238	1	0,5	4	116	900	700	M9x1	RVS	EGO EGO Gico	55.10542.807 55.19542.140 5340011200

Tabel wordt vervolgd op de volgende pagina

afb.	bestelnr.	T.uit (°C)	aantal polig (-polig)	SC (A)	voeler ø (mm)	voeler L (mm)	cap. (mm)	capillaire pijp geïsoleerd (mm)	stopbus	voeler	passend voor	fabrikantnr.
3	9690.2333	350	1	16	3,1	201	870	870	-	RVS	Coven EGO	EMTSS350 55.19562.040
3	9690.2242	355	1	0,5	4	120	870	870	-	RVS	Anitec EGO EGO GIGA Star10	Y16500 55.10572.800 55.19572.010 Y16500 Y16500
4	9315.0310	230	1	0,5	11	16,5	850	850	-	-	Angelo-Po EGO EGO EGO Gico Silko	32Z8000 55.10542.190 55.10542.828 55.19542.050 55.19542.190 5340101230 SIR0101386
4	9283.0680	230	1	0,5	11	18	900	-	-	-	EGO EGO Modular	55.10542.827 55.19542.170 66103400
4	9025.0330	230	1	16	11	28	850	830	-	-	Bertos EGO EGO GIGA Silko Star10	22070432 55.10542.850 55.19542.030 0000X43400 SIR0109053 0000X43400

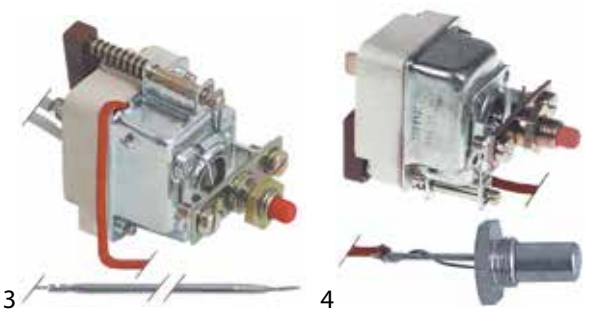
## serie 55.11\_



afb.	bestelnr.	T.uit (°C)	aantal polig (-polig)	SC (A)	voeler ø (mm)	voeler L (mm)	cap. (mm)	capillaire pijp geïsoleerd (mm)	stopbus	voeler	passend voor	fabrikantnr.
1	9690.4350	80	1	16	4	89	195	-	-	-	EGO Lincat Scholl	55.11119.010 TH35 70.10.07
1	9690.2260	120	1	16	4	91	280	-	M9x1	RVS	EGO	55.11529.090
1	9162.0300	170	1	16	3,1	160	650	600	-	-	EGO Electrolux Emainox Zanussi	55.11539.801 031482 3700014 031482
1	9690.0336	240	1	16	4	91	530	350	-	RVS	Bartscher Capic EGO Piemme Roller-Grill Saro Valentine	A010501 E401002 55.11549.080 0024 A06004 34-1370 9021-53
1	9690.2199	245	1	16	6	77	2290	2260	-	RVS	EGO Fagor	55.11549.050 12024600
2	9690.4351	92	1	16	9/15	20	50	-	-	-	EGO Fagor	55.11519.030 12023818



Serie 55.13\_



afb.	bestelnr.	T.uit (°C)	aantal polig (-polig)	SC (A)	voeler ø (mm)	voeler L (mm)	cap. (mm)	capillaire pijp geïsoleerd (mm)	stopbus	voeler	passend voor	fabrikantnr.
1	9690.4765	60	1	16	6	74	520	430	-	-	EGO	55.13519.190
1	9108.0068	98	1	16	8	81	1050	-	-	-	Animo EGO	03047 55.13519.070
1	9010.0120	110	1	16	6	98	2930	500/500	-	RVS	EGO Krefft	55.13526.010 602864
1	9690.4347	115	1	16	6	78	350	-	M9x1	-	CoffeeQueen EGO	220220 55.13521.010
1	9690.2275	125	1	16	4	128	1130	800	-	RVS	EGO Hobart	55.13523.060 227879
1	9162.0664	126	1	16	6	129	1730	800	M9x1	-	EGO Electrolux Therma Zanussi	55.13525.050 0E5086 0E5086 0E5086
1	9690.2185	130	1	16	6	77	830	700	M9x1	-	EGO	55.13522.380
1	9690.4348	130	1	16	6	129	830	-	-	RVS	EGO Küppersbusch MKN Thielmann	55.13522.090 540414 203480 143830
1	9108.0070	132	1	16	3,1	248	830	-	M9x1	RVS	Animo EGO EGO	03093 55.13522.020 55.13522.400
1	9690.4349	132	1	16	3,1	248	830	-	M9x1	RVS	EGO Falcon	55.13522.020 734311090
1	9690.2316	135	1	16	6	77	520	-	-	RVS	Convotherm EGO	5001026K 55.13529.210
1	9690.4769	140	1	16	4	125	900	420	-	-	EGO	55.13522.470
1	9690.2327	140	1	16	6	77	870	790	-	RVS	EGO Franke Salvis	55.13522.200 178982 178982
1	9690.0725	140	1	16	6	77	1540	1350	-	RVS	EGO Jemi Morice	55.13529.170 2006062 TH1290
1	NML	140	1	16	6	78	1500	-	-	-	Bourgeois EGO	THER013 55.13524.030
1	9690.0870	145	1	16	4	100	1130	-	-	RVS	EGO Wiesheu-Wiwa	55.13523.070 9030-145-001
1	9690.4346	145	1	16	6	73	830	-	-	RVS	Casta EGO Jünger	99900159 55.13522.050 422000
1	9998.1670	150	1	16	6	83	830	-	-	RVS	EGO	55.13522.190
1	9705.1495	160	1	16	6	75	1540	1490	-	RVS	EGO EGO	55.13522.070 55.13539.040
1	9162.2340	190	1	16	3,1	178	350	-	M9x1	RVS	EGO Electrolux Juno Therma	55.13531.010 0H6142 0H6142 0H6142
1	9960.0000	220	1	16	6	77	830	-	M9x1	-	EGO KSF Morice	55.13542.200 4.011.03.03 TH1120
1	9690.4766	225	1	16	6	88	900	-	-	-	Capic EGO	E401007 55.13542.140
1	9690.4768	225	1	16	11	16,5	830	-	-	-	EGO Fagor	55.13542.110 12017873
1	9000.0025	230	1	16	6	77	670	180	-	-	EGO Lincat Parry	55.13549.010 TH11 —

Tabel wordt vervolgd op de volgende pagina





afb.	bestelnr.	T.uit (°C)	aantal polig (-polig)	SC (A)	voeler ø (mm)	voeler L (mm)	cap. (mm)	capillaire pijp geïsoleerd (mm)	stopbus	voeler	passend voor	fabrikantnr.
1	9690.2590	230	1	16	6	96	1050	-	M9x1	RVS	EGO Lincat	55.13549.030 TH51
1	9690.4770	234	1	16	6	98	1090	660	M9x1	-	EGO	55.13549.060
1	9690.0372	246	1	16	6	77	830	-	-	RVS	EGO	55.13542.900
1	9690.4352	246	1	16	6	77	830	-	M9x1	-	EGO MKN	55.13542.100 203492
1	9690.4771	290	1	16	4	111	710	450	-	RVS	EGO FriFri	55.13549.050 400375
1	9690.4353	314	1	16	6	77	870	-	M9x1	-	EGO	55.13562.090
1	9690.4354	320	1	16	6	77	1540	1250	-	-	EGO	55.13569.070
1	9690.4355	329	1	16	3,03	160	1230	1060	-	-	EGO Fagor	55.13569.010 12019062
1	9690.4356	340	1	16	3	160	870	600	-	-	EGO Repagas	55.13562.170 010677
1	9690.4357	340	1	16	3,1	201	1170	-	-	RVS	Convotherm EGO	5001029K 55.13563.020
1	9690.4358	350	1	16	3,03	141	830	450	-	RVS	EGO Electrolux Juno	55.13562.060 0H6243 0H6243
1	9690.4360	360	1	16	3,03	160	870	700	-	-	EGO Fagor	55.13572.090 12024591
1	9690.4359	365	1	16	3	160	1730	1710	-	-	Ambassade Bartscher Bonnet Capic EGO Thirode	6538562 020411 905886 E401003 55.13575.020 905886
1	9690.4362	420	1	16	3,9	228	1130	700	-	-	EGO Fagor	55.13583.010 12024691
2	9690.0224	178	1	16	4	91	1730	1600	-	-	EGO Electrolux Juno MKN	55.13525.010 0H6141 0H6141 203185
3	9690.4363	291	1	16	5	90	870	-	-	RVS	EGO Electrolux Juno	55.13552.160 0K1877 0K1877



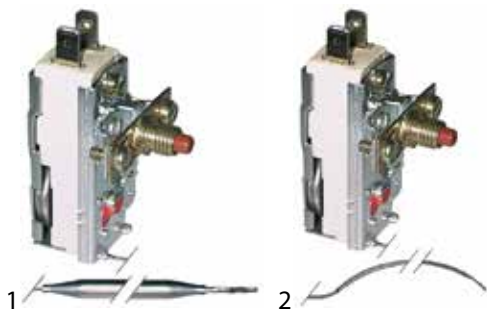

serie 55.14\_



afb.	bestelnr.	T.uit (°C)	aantal polig (-polig)	SC (A)	voeler ø (mm)	voeler L (mm)	cap. (mm)	capillaire pijp geïsoleerd (mm)	stopbus	voeler	passend voor	fabrikantnr.
1	9690.4772	98	1	16	6	86	1500	-	-	-	EGO	55.14514.805
1	9690.4365	230	1	16	6	74	600	-	-	RVS	EGO Elframo Komel	55.14549.804 22130001 22130001
1	9998.0026	240	1	16	6	77	1280	1050	M10x1	RVS	Baron EGO Electrolux Emmepi Giorik Silko	A6010006 55.14549.826 003121 808430 6010006 SIR0108011
1	9690.0470	340	1	16	3,03	144	880	750	M9x1	-	EGO Inoxtrend	55.14562.803 C2198-00
2	9690.4367	250	1	16	3,03	160	880	800	-	RVS	EGO	55.14542.040
2	9690.4368	250	1	16	3,03	160	990	800	-	RVS	EGO	55.14549.020

serie 55.31\_



afb.	bestelnr.	T.uit (°C)	aantal polig (-polig)	SC (A)	voeler ø (mm)	voeler L (mm)	cap. (mm)	capillaire pijp geïsoleerd (mm)	stopbus	voeler	passend voor	fabrikantnr.
1	9690.2209	115	3	20	6	173	830	770	-	RVS	EGO Palux	55.31522.060 294020
1	9162.1566	140	3	20	6	173	830	800	-	RVS	EGO Electrolux Juno Zanussi	55.31532.060 051644 051644 051644
1	9690.2347	160	3	0,5	6	173	830	800	-	RVS	EGO Electrolux Zanussi	55.31532.050 051637 051637
1	9690.4567	225	3	20	6	157	940	800	-	RVS	EGO Electrolux Zanussi	55.31549.050 059552 059552
1	9690.2329	225	3	20	6	269	830	-	-	-	EGO Hobart Lincat	55.31542.100 4936005 TH19
1	9220.0650	230	3	20	6	219	1730	1400	-	RVS	EGO Krefft Küppersbusch	55.31545.020 49-176174 176174
1	9690.1170	230	3	20	6	239	830	-	-	RVS	EGO Elframo Komel Olis Repagas	55.31542.140 22150001 22150001 BN6A046900 8700021
1	9690.2305	250	3	20	6	219	1430	1100	-	RVS	EGO Malag	55.31544.030 174963

Tabel wordt vervolgd op de volgende pagina



afb.	bestelnr.	T.uit (°C)	aantal polig (-polig)	SC (A)	voeler ø (mm)	voeler L (mm)	cap. (mm)	capillaire pijp geïsoleerd (mm)	stopbus	voeler	passend voor	fabrikantnr.
1	9162.2566	250	3	20	6	239	2530	1600/210	-	RVS	EGO Electrolux Juno Zanussi	55.31549.040 054932 054932 054932
1	9162.1516	250	3	20	6	239	2530	1600/210/375	-	RVS	EGO Electrolux Zanussi	55.31546.020 051369 051369
1	9162.1758	250	3	1x20/2x0,5	6	157	1230	800	-	RVS	EGO Electrolux Therma Zanussi	55.31549.020 052331 052331 052331
1	9162.6915	285	3	1x20/2x0,5	6	157	940	940	-	-	EGO Electrolux Zanussi	55.31559.020 053183 053183
1	9690.2201	290	3	20	6	220	840	-	-	-	EGO FriFri	55.31552.150 400189
1	375679	295	3	20	4	157	670	350	-	RVS	EGO FriFri	55.31549.930 400364
1	9162.1522	350	3	20	6	157	940	890	-	RVS	EGO Electrolux Juno Zanussi	55.31566.010 051454 051454 051454
1	9690.2246	350	3	1x20/2x0,5	6	157	1230	1100	-	-	Bake-Off EGO Electrolux Juno Zanussi	182500022 55.31569.010 051643 051643 051643
2	9690.2261	135	3	20	6	173	1430	800	M9x1	RVS	EGO MKN Palux	55.31524.030 203493 291749
2	9030.0300	230	3	20	6	167	830	600	M10x1	-	EGO EGO Ilsa Mareno	55.31542.120 55.31542.240 5531542120 MA1037035900
2	9690.2269	230	3	20	6	239	830	-	M9x1	RVS	EGO Mareno Modular Multi Nayati	55.31542.050 733100 66100900 661009 G52229
2	9005.0096	240	3	20	6	177	2380	1100	M9x1	RVS	EGO EGO EGO Electrolux King MKN	55.31549.010 55.31549.060 97.55315.089 0H7487 0H7487 203482
2	9690.0920	320	3	20	6	177	1430	800	M9x1	RVS	EGO Electrolux Juno	55.31554.020 0H6136 0H6136
3	9191.0032	220	3	20	14	105	820	660	-	-	EGO Mareno Palux	55.31542.080 MA893100 088562



serie 55.32\_



afb.	bestelnr.	T.uit (°C)	aantal polig (-polig)	SC (A)	voeler ø (mm)	voeler L (mm)	cap. (mm)	capillaire pijp geïsoleerd (mm)	stopbus	voeler	passend voor	fabrikantnr.
1	9690.2268	105	3	20	4	107	410	250/280	-	-	EGO	55.32521.160
1	9690.4370	105	3	20	6	94	1490	1350	M9x1	RVS	EGO	55.32524.170
1	9690.2204	108	3	20	3	190	600	600	-	RVS	EGO Elettrobar	55.32519.801 236032
1	9690.2274	110	3	20	6	74	2000	2000	-	-	Adler EGO Rosinox	20503 55.32519.802 RX94800505
1	9690.4773	110	3	20	6	95	1500	1400	-	-	Dihl EGO Kromo	DW15553 55.32524.140 DW15553
1	9690.2271	118	3	20	6	74	900	900	-	RVS	EGO Elframo Komel	55.32529.801 22100002 22100002
1	9901.0165	120	3	20	6	94	540	500	-	RVS	EGO Meiko Rhima	55.32529.190 9502526 5315797
1	9690.3072	120	3	20	6	94	900	850	-	-	EGO Mareno Silko	55.32522.858 CR0585120 CR0585120
1	9108.2090	130	3	20	3	300	1500	450	M9x1	RVS	Animo EGO	03106 55.32524.070
1	9690.4371	132	3	20	6	87	890	850	-	RVS	Baron Cookmax EGO EGO Olis	6A049407 6A049407 55.32522.550 55.32522.845 BN6A049407
1	9700.0755	132	3	2x20/1x0,5	6	77	890	-	M10x1	RVS	Baron Cookmax EGO Mareno Rosinox Silko	MA1878900 1878900 55.32522.843 MA1878900 RX94812642 MA1878900
1	9690.4372	135	3	20	3,1	225	890	890	-	RVS	EGO MBM-Italia	55.32522.814 RTCP900074
1	9690.4774	135	3	20	6	73	1490	1350	M9x1	RVS	Desco EGO Electrolux Juno Mareno Therma	60774 55.32524.160 0K3967 0K3967 MA2613300 0K3967
1	9690.4373	139	3	2x20/1x0,5	6	77	890	-	M9x1	RVS	Angelo-Po EGO Mareno	32V398 55.32522.810 MA2865100
1	9163.4560	140	3	20	6	88	900	770	-	-	EGO Electrolux	55.32522.480 0C2983
1	9700.1125	140	3	20	6	89	900	900	-	RVS	Angelo-Po EGO EGO Electrolux Lasa Mareno	32Z2011 55.32522.815 55.32522.846 004862 3267260 1037305000
1	9690.2236	140	3	20	6	173	830	800	-	RVS	EGO Modular	55.32522.808 66105100
1	9690.4374	145	3	20	3	178	1790	-	M9x1	-	EGO Electrolux Juno Therma	55.32525.060 0H6219 0H6219 0H6219

Tabel wordt vervolgd op de volgende pagina



afb.	bestelnr.	T.uit (°C)	aantal polig (-polig)	SC (A)	voeler ø (mm)	voeler L (mm)	cap. (mm)	capillaire pijp geïsoleerd (mm)	stopbus	voeler	passend voor	fabrikantnr.
1	9690.2222	150	3	0,5	3	188	1100	-	-	RVS	Bertos EGO Emmepi Rosinox Silko	31290200 55.32529.810 808203 RX94812646 SIR0102493
1	9690.3095	150	3	16	6	98	4800	-	-	-	EGO Meiko	55.32527.010 9500473
1	9130.0326	150	3	20	3,1	219	890	890	-	-	Ambach EGO	5061603828 55.32522.827
1	9690.2221	150	3	20	6	79	900	700	-	-	Baron EGO Emmepi Giorik Rosinox Silko	BN41826630350 55.32522.811 808057 6010002 RX94805413 SIR0108113
1	9882.0040	150	3	20	6	87	1490	1250	M9x1	RVS	Angelo-Po EGO Faema	3222710 55.32524.030 3231133006
1	9690.2460	154	3	20	6	87	890	800	-	-	Bezzera EGO Reneka	7434001 55.32522.210 9101000
1	9690.4375	156	3	20	6	87	1490	1350	-	-	Angelo-Po	3014261
1	9690.2293	160	3	20	6	87	890	880	-	RVS	Bertos EGO Foinox Inoxtrend Whirlpool	25070100 55.32532.809 3023 LC-351 483286002546
1	9690.2247	160	3	20	6	89	900	900	-	RVS	Cookmax EGO Olis	6A049405 55.32532.805 BN6A049405
1	9690.2220	165	3	20	6	77	2440	800	M9x1	RVS	EGO	55.32539.030
1	9239.0650	169	3	20	4	128	890	210/210	-	RVS	Astoria Carimali EGO Elektra Faema Gaggia La Cimbali La San Marco La-Spaziale QualityEspresso Rancilio Sanremo	20300015 95.01594 55.32532.020 02790035 531-193 100 07476906 531-193-100 108463 1477 07476906 34200095 10111015
1	9163.3360	170	3	0,5	6	87	900	800	-	-	EGO Electrolux Zanussi	55.32532.824 005295 005295
1	9690.4376	177	3	20	4	130	1500	420	-	-	EGO La-Scala	55.32534.802 C-0457
1	9025.0660	180	3	20	4	120	3000	3000	-	-	Bertos EGO Firex GIGA Lincar Offcar Olis	35300000 55.32532.829 40100041 E10500 40000926 FX40100041 BN6A001415
1	9690.4377	196	3	20	6	87	890	350	-	-	EGO Meiko	55.32532.190 9502027
1	9005.0044	220	3	20	6	133	1890	700	-	RVS	Alpeninox EGO Electrolux	0A2204 55.32549.060 0A2204

Tabel wordt vervolgd op de volgende pagina



afb.	bestelnr.	T.uit (°C)	aantal polig (-polig)	SC (A)	voeler ø (mm)	voeler L (mm)	cap. (mm)	capillaire pijp geïsoleerd (mm)	stopbus	voeler	passend voor	fabrikantnr.
1	9690.4378	225	3	20	6	94	900	670	M10x1	RVS	EGO Lincar Offcar Silko	55.32542.835 40000922 862124 0108066
1	9163.3080	230	1	20	6	87	890	-	-	RVS	Ambach EGO Electrolux	5061614325 55.32542.836 0C4279
1	9023.0020	230	3	20	6	79	1700	1100	-	RVS	Bertos EGO	33070800 55.32549.812
1	9690.2283	230	3	20	6	87	890	-	-	RVS	EGO	55.32542.813
1	9015.0218	230	3	20	6	87	1490	1100	M9x1	RVS	Ambach Baron EGO EGO Küppersbusch Thielmann	5061603893 BN41826630380 55.32542.070 55.32544.050 540443 144182
1	9998.2030	230	3	20	6	89	3000	2650	M9x1	RVS	EGO Mareno	55.32546.801 MA1982000
1	9690.1160	230	3	20	6	94	900	670	M10x1	RVS	Baron EGO Giorik Ilsa Lincar MBM-Italia Offcar Rosinox	BN4185326010036 55.32542.857 6010036 31230 40000919 RTBF900081 862123 RX94046363
1	9089.0018	232	3	20	6	94	900	670	M10x1	RVS	EGO Emmepi Giorik MBM-Italia Palux Rosinox Silko	55.32542.822 807349 6010037 RTBF800164 961809 RX94812594 SIR0108065
1	9130.0590	235	3	20	4	120	1800	1600	-	RVS	Ambach EGO GIGA	5061610988 55.32545.802 AEC001ZR10
1	9610.0110	235	3	20	6	87	1790	1710	M9x1	RVS	Ambach EGO Electrolux Gastrofrit Inoksan KSF Lotus Ubert	5061603893 55.32545.090 0KJ144 306025.010 10100051 4.011.03.03 537001400 342212
1	9700.0295	236	3	20	6	77	1190	990	-	-	Baron Cookmax EGO Mareno	1878600 1878600 55.32543.803 MA1878600
1	9690.4380	237	3	20	6	98	1420	1170	-	-	Berner EGO	300109 55.32544.160
1	9690.0895	240	3	20	3,1	226	890	-	-	RVS	EGO	55.32542.050
1	9690.2265	240	3	20	4	157	890	350	-	RVS	EGO Electrolux Valentine	55.32542.230 0K5033 0705-02
1	9283.0410	240	3	20	6	79	900	900	-	RVS	EGO Modular	55.32542.807 66104800
1	9999.9997	240	3	20	6	87	890	600	-	RVS	EGO Haka Morice	55.32542.130 9047 TH1087
1	9690.2598	240	3	20	6	87	2000	1800	-	RVS	Angelo-Po Anitec EGO Morice Star10	32Z3631 072027 55.32549.050 TH1087 072027
1	9162.4085	245	3	0,5	6	79	900	900	-	RVS	EGO Electrolux Zanussi	55.32549.814 006282 006282
1	9690.1025	245	3	20	4	120	1800	1800	-	RVS	Baron Bartscher Cookmax EGO Olis	BN8219602 023965 8219602 55.32545.800 BN8219602
1	9690.0875	245	3	20	6	75	900	670	M10x1	RVS	EGO Silko	55.32542.803 SIR0108061

Tabel wordt vervolgd op de volgende pagina



afb.	bestelnr.	T.uit (°C)	aantal polig (-polig)	SC (A)	voeler ø (mm)	voeler L (mm)	cap. (mm)	capillaire pijp geïsoleerd (mm)	stopbus	voeler	passend voor	fabrikantnr.
1	9690.475	245	3	20	6	78	1500	1050	M9x1	-	Bartscher Charvet EGO	049050 07665A 55.32544.130
1	9162.5100	245	3	20	6	87	2700	1600	-	RVS	EGO Electrolux Zanussi	55.32549.811 004472 004472
1	9000.0420	246	3	20	6	79	1300	1100	-	RVS	EGO Forved	55.32549.824 03299/A
1	9690.4060	250	3	20	6	87	2310	2300	-	RVS	EGO GIGA	55.32549.806 X43700
1	9162.2345	250	3	20	6	89	900	900	-	RVS	EGO Electrolux Zanussi	55.32542.859 005941 005941
1	9191.0132	255	3	20	3,1	307	730	700	-	RVS	EGO Palux	55.32559.010 027332
1	9690.4382	255	3	20	6	77	1490	1100	-	RVS	EGO Roka	55.32554.060 8900253
1	9162.4430	270	3	20	6	79	900	900	-	RVS	EGO Electrolux Zanussi	55.32552.814 006307 006307
1	9690.4383	270	3	20	6	79	2000	-	-	RVS	Angelo-Po EGO	32V6560 55.32559.814
1	9690.4384	285	1	0,5	4	120	1500	1500	-	-	Angelo-Po EGO	32Z5610 55.32554.800
1	9163.2360	295	3	20	4	120	1800	-	-	-	EGO Electrolux	55.32555.800 004921
1	9998.0520	315	3	20	6	77	1490	1100	M9x1	RVS	EGO Electrolux Juno Krefft	55.32564.010 0H6215 0H6215 99-213149
1	9690.4385	325	3	20	3,1	188	900	700	M10x1	RVS	EGO Mareno	55.32562.810 MA2864714
1	9690.4386	340	3	20	4	128	1190	-	-	RVS	EGO Lohberger	55.32563.010 51440160
1	9690.4776	345	3	20	4	120	900	900	-	RVS	EGO Rosinox Silko	55.32562.835 RX94812622 SJR0101372
1	9162.1575	350	3	0,5	6	79	3000	2800	-	RVS	EGO Mareno	55.32566.800 1475513
1	9690.4387	350	3	20	3	188	900	900	-	RVS	Casta EGO Gico Ilisa Lincar MBM-Italia Offcar Olis Smeg	85900019 55.32562.808 53403000350 843737 40000920 RTCU800152 843737 A046150 818731004
1	9690.4388	350	3	20	4	120	900	670	M10x1	RVS	EGO Giorik Lincar	55.32562.807 6010008 40000923
1	9283.1160	350	3	20	4	120	900	900	-	-	EGO Modular	55.32562.802 66104500
1	9690.4389	350	3	20	6	77	890	-	-	RVS	EGO Küppersbusch Thielmann	55.32562.090 540470 251116

Tabel wordt vervolgd op de volgende pagina



afb.	bestelnr.	T.uit (°C)	aantal polig (-polig)	SC (A)	voeler ø (mm)	voeler L (mm)	cap. (mm)	capillaire pijp geïsoleerd (mm)	stopbus	voeler	passend voor	fabrikantnr.
1	9998.1765	350	3	20	6	77	1490	800	-	RVS	EGO Electrolux Juno Öztiryakiler Therma	55.32564.040 006826 006826 6234.00001.28 006826
1	9690.4777	350	3	20	6	79	900	700	-	RVS	EGO Emmepi	55.32562.829 C00098
1	NML	350	3	20	6	89	1000	960	-	RVS	EGO Olis Tecnoeka	55.32569.800 BN6A046160 09950347000
1	9025.0320	350	3	20	6	89	3000	960	-	-	Anitec EGO GIGA Star10	X44800 55.32566.806 X44800 X44800
1	9690.4390	355	3	20	4	120	1890	-	-	-	EGO MIWE	55.32579.040 504024.30
1	9690.4391	360	3	20	3,1	188	1490	800	-	RVS	EGO Electrolux Emmepi Giorik Juno Multi Olis Smeg Tecnoinox Zanussi	55.32574.040 004919 807790 5910029 004919 661045 BN6A046150 818731004 RC00305000 004919
1	9162.4975	360	3	20	4	120	900	900	-	RVS	Baron Cookmax EGO Electrolux Zanussi	41826630130 41826630130 55.32562.806 004269 004269
1	9690.0720	360	3	20	4	120	1490	1450	-	RVS	Ambach Convotherm EGO EGO GIGA MKN Silko Wiesheu-Wiwa	5061616223 5001039 55.32574.110 55.32579.010 Y72100 203484 SIR0101375 38643
1	9690.4392	360	3	20	4	120	1800	1800	-	RVS	Bertos EGO Firex GIGA Lincar Lotus Modular Offcar Star10	35301400 55.32575.801 40100062 Y16600 40000921 40100062 40100062 FX40100062 X49900
1	AAJ526241	360	3	2x20/1x0,5	6	79	890	-	-	RVS	Baron Cookmax EGO Silko	MA1878500 1878500 55.32562.822 MA1878500
1	9162.7270	360	3	1x20/2x0,5	6	79	1200	1200	-	RVS	EGO Electrolux Zanussi	55.32573.801 004600 004600
1	9690.4393	365	3	20	4	100	1190	400	-	RVS	EGO Palux	55.32573.100 502537
1	9690.4394	365	3	20	4	120	1300	1250	-	RVS	Angelo-Po EGO EGO	32Z9202 55.32569.814 55.32579.800
1	9960.0020	400	3	20	3,9	228	1190	-	-	RVS	Bonnet Capic EGO Küppersbusch Morice Thielmann	301049 E401090 55.32573.030 540406 TH1122 144095
1	9162.8903	420	3	20	3,9	306	870	850	-	RVS	EGO EGO Lotus MBM-Italia Olis	55.32582.804 55.32582.807 537012800 RTBF800192 BN6A046180

Tabel wordt vervolgd op de volgende pagina

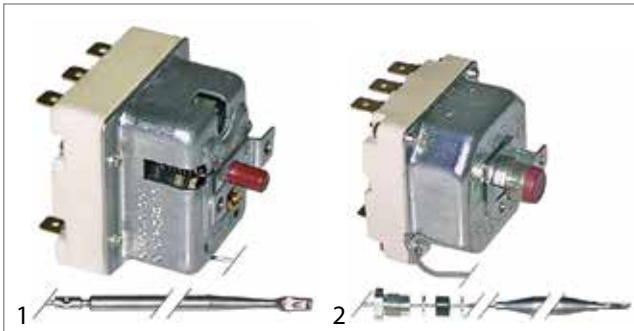
afb.	bestelnr.	T.uit (°C)	aantal polig (-polig)	SC (A)	voeler ø (mm)	voeler L (mm)	cap. (mm)	capillaire pijp geïsoleerd (mm)	stopbus	voeler	passend voor	fabrikantnr.
1	9095.0180	480	3	20	4	230	890	-	-	-	EGO Küppersbusch Palux	55.32582.020 540559 603589
1	9690.4395	500	3	20	4	308	890	-	-	RVS	EGO Eloma OEM Zanolli	55.32582.800 55.32582.815 ELE336005 ED05500 TERM0005
1	9690.4396	520	3	20	3,9	228	890	400	-	-	EGO Palux	55.32582.030 619221
1	9095.0585	560	3	20	3,9	228	870	700	-	-	Cuppone EGO Electrolux Pizza-Group	91310051 55.32582.814 004205 A88TX85001
1	9690.4399	580	3	20	4	163	1200	-	-	-	Ambach EGO Inoksan Pizza-Group	5061621356 55.32583.804 10100001 A88TX85003
2	9690.4400	125	1	0,5	4	120	900	900	-	RVS	EGO Rosinox Silko	55.32522.831 RX94805231 SIR0101404
2	9690.2291	147	1	20	6	89	900	800	-	-	Baron EGO Lotus	BN41853310064 55.32522.837 10064
2	ALA130081	150	1	20	6	89	900	800	-	-	Ambach EGO Lainox	R65070081 55.32522.852 LAR65070081
2	9162.2638	245	1	0,5	6	77	1290	1100	-	RVS	EGO EGO EGO Electrolux Zanussi	55.32542.807 55.32549.816 55.32549.827 0A5435 0A5435
2	9162.1450	259	1	20	6	88	900	100	-	-	EGO Electrolux	55.32542.858 005931
2	9315.0300	299	1	20	4	123	1500	1400	-	-	Angelo-Po EGO	32Z5612 55.32554.080
2	9690.4401	325	1	0,5	3	188	900	-	-	-	Baron EGO Mareno	MA1942900 55.32562.828 MA1942900
2	9690.4778	340	1	0,5	3	190	900	900	-	RVS	EGO Gico	55.32562.800 53403000340
2	9134.0294	344	1	20	6	79	900	900	-	-	Comenda EGO Lainox	M100780 55.32562.820 LAR65070060
2	9315.0605	360	1	0,5	4	120	1500	1500	-	-	Ambach Angelo-Po EGO Electrolux Rosinox	AM5061638556 32Z1400 55.32574.800 OPRE75 RX94800158
2	9162.2280	360	1	0,5	6	74	1500	1500	-	-	EGO Electrolux Juno Zanussi	55.32574.801 003594 003594 003594

Tabel wordt vervolgd op de volgende pagina





afb.	bestelnr.	T.uit (°C)	aantal polig (-polig)	SC (A)	voeler ø (mm)	voeler L (mm)	cap. (mm)	capillaire pijp geïsoleerd (mm)	stopbus	voeler	passend voor	fabrikantnr.
3												
4												
5												
6												
2	9690.2432	360	1	0,5	6	79	890	-	-	RVS	Baron Cookmax EGO	41826630010 41826630010 55.32562.819
2	9690.4402	360	3	20	4	120	1800	1800	-	RVS	GIGA Lotus Offcar	X49900 40100062 FX40100062
2	9690.4403	368	3	16	3	160	1490	76			Ambassade EGO	6539942 55.32574.080
2	9690.4779	380	2	20	4	163	1190	800	-	RVS	EGO Franke Salvis	55.32573.060 1G962526 1G962526
3	9690.4404	130	3	20	6	88	880	-	-	-	Capic Capic EGO	E401008 E401012 55.32522.160
4	9690.0635	225	3	20	11	26	890	700	-	-	EGO EGO Elettrobar Gico	55.32542.150 55.32542.806 236016 53403901221
5	9700.0285	230	2	1x20/1x0,5	6	74	880	-	M9x1	RVS	EGO Mareno	55.32542.833 MA1871100
5	9690.4397	340	2	1x20/1x0,5	4	120	1300	900	-	-	AltoShaam Angelo-Po Convotherm EGO EGO	TT-33325 3111950 5001031 55.32559.805 55.32569.050
5	9998.4963	350	2	0,5	4	120	1300	900	3/8" NPT	-	EGO Sogeco	55.32569.815 TERMOSTATO003
6	9700.0940	230	3	2x20/1x0,5	4	120	900	700	-	-	Baron EGO Mareno Modular Rosinox Silko	MACM097701 55.32542.370 MACM097701 96104400 RX94812559 MACM097701



afb.	bestelnr.	T.uit (°C)	aantal polig (-polig)	SC (A)	voeler ø (mm)	voeler L (mm)	cap. (mm)	capillaire pijp geïsoleerd (mm)	stopbus	voeler	passend voor	fabrikantnr.
7	9690.4398	305	3	20	4	128	890	800	-	-	EGO Eloma Falcon	55.32562.160 EL0572705 530368679
8	9134.0298	330	3	20	11	18,5	900	900	-	-	Angelo-Po CB EGO Lainox Tecnoinox	32Z6790 09010019 55.32562.804 LAR65070050 RC00238000
8	9690.2400	350	1	16	11	16	900	900	-	-	EGO Electrolux Juno Lainox Therma Zanussi	55.32562.816 002730 002730 LAR65070070 002730 002730
8	9134.0308	360	1	20	11	16	900	900	-	-	Ambach Cookmax EGO Kelvin Lainox Rosinox	R65070350 R65070350 55.32572.804 01011105 LAR65070350 RX94814230
9	9163.0235	338	2	1x20/1x0,5	6	53	900	900	-	-	EGO Electrolux Zanussi	55.32562.847 007042 007042

## serie 55.33\_

afb.	bestelnr.	T.uit (°C)	aantal polig (-polig)	SC (A)	voeler ø (mm)	voeler L (mm)	cap. (mm)	capillaire pijp geïsoleerd (mm)	stopbus	voeler	passend voor	fabrikantnr.
1	9108.2125	90	3	20	6	114	380	360	-	-	Animo EGO	03089 55.33511.010
1	9690.4412	100	3	20	4	231	870	800	-	RVS	EGO Hobart	55.33512.020 378791
1	9690.4413	160	3	20	4	155	880	350	-	RVS	Astoria Cookmax EGO WEGA	WY20300019 WY20300019 55.33532.130 WY20300019
1	9690.2446	220	3	20	6	75	1500	-	M9x1	RVS	Capic EGO Morice	E401006 55.33544.020 TH0118
1	9690.4780	220	3	20	6	107	870	800	-	-	Ambassade Bartscher EGO Elframo Komel	6537879 06537879 55.33542.040 22150003 22150003
1	9690.4414	230	3	20	6	88	2200	-	-	-	Charvet EGO Imperial-Germany	05996A 55.33549.030 8038266
1	9690.4415	230	3	20	6	103	1170	-	-	-	EGO Lincat	55.33543.020 TH61

Tabel wordt vervolgd op de volgende pagina

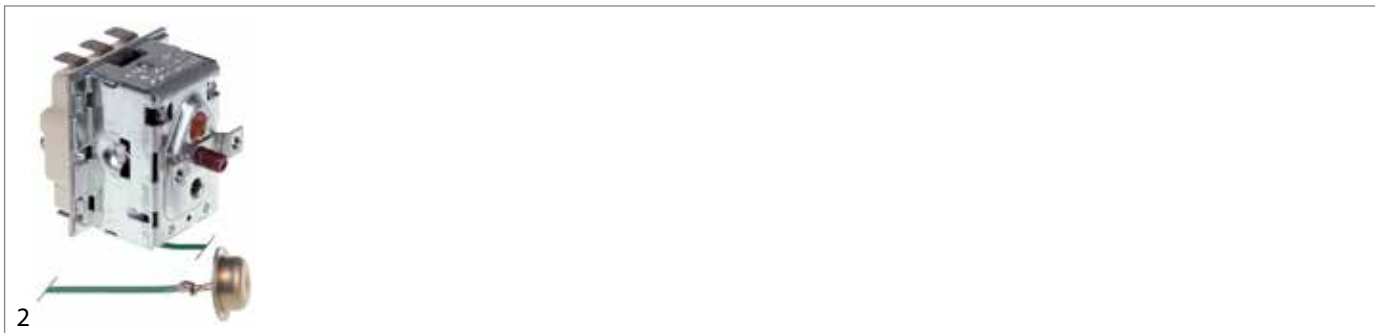

afb.	bestelnr.	T.uit (°C)	aantal polig (-polig)	SC (A)	voeler ø (mm)	voeler L (mm)	cap. (mm)	capillaire pijp geïsoleerd (mm)	stopbus	voeler	passend voor	fabrikantr.
1	9690.4416	230	3	20	6	107	870	-	-	-	EGO Lincat	55.33542.090 TH25
1	9925.0305	230	3	20	6	117	1470	1100	M9x1	RVS	EGO Gastrofrit MKN	55.33542.050 55.33544.010 306025.005 203489
1	9690.4418	235	3	20	6	108	1470	1100	-	-	EGO Falcon	55.33544.050 539113830
1	9835.0390	240	3	20	3,1	226	1170	960	-	RVS	Ascobloc EGO Küppersbusch	8152102 55.33543.010 152102
1	9220.0990	250	3	20	3,1	307	710	700	-	RVS	EGO Küppersbusch Palux	55.33559.020 540579 686832
1	9690.4417	250	3	20	6	107	1470	1100	M9x1	RVS	EGO Lohberger MKN Palux	55.33544.040 F2072038 203183 637726
1	9690.4419	275	3	20	4	157	870	350	-	RVS	EGO Franke Nayati Salvis	55.33542.030 1G962532 PD412F 1G962532
1	9993.0724	282	3	20	4	157	1770	1490	-	RVS	EGO Fagor Valentine	55.33555.030 12124621 6313-SA
1	9690.4420	285	3	20	4	128	870	350	-	RVS	EGO Valentine	55.33542.100 0705-04
1	9690.4421	295	3	20	4	128	1770	1750	-	RVS	EGO Electrolux Valentine	55.33555.010 OKI686 6314-SA
1	9690.4422	300	3	20	4	157	520	-	-	RVS	EGO TurboChef	55.33559.030 102075
2	9690.4423	360	3	20	15	8	1150	1100	-	-	EGO Eloma Falcon Palux	55.33573.070 EL0580457 530336027 580457



## serie 56\_

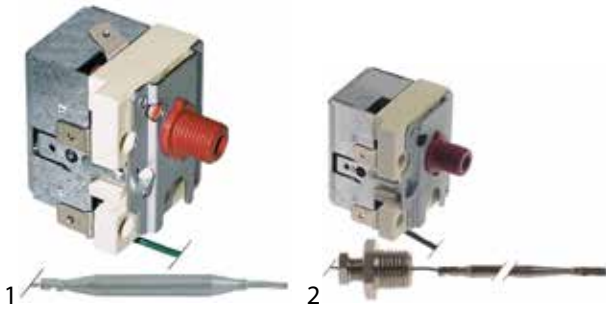

afb.	bestelnr.	T.uit (°C)	aantal polig (-polig)	SC (A)	voeler ø (mm)	voeler L (mm)	cap. (mm)	capillaire pijp geïsoleerd (mm)	stopbus	voeler	passend voor	fabrikantnr.
1	9690.2343	132	1	16	3,1	200	860	400	M9x1	-	Cookmax EGO Melitta	17764 56.10522.560 17764
1	9690.2287	147	1	16	6	77	1860	1350	-	-	EGO Küppersbusch	56.10529.520 152433
1	9690.2255	150	1	16	6	77	1460	1100	M9x1	-	EGO Fagor	56.10529.510 12024884
1	9690.2326	157	1	16	6	62	1520	1380	-	-	EGO Rational	56.10534.500 40.02.515
1	9690.2334	183	1	16	6	61	1460	1400	-	RVS	EGO Rational	56.10534.510 40.01.329
1	9690.2306	230	1	0,5	6	77	700	-	M9x1	RVS	EGO Falcon Nayati	56.10549.510 731350021 GS2154
1	9690.4781	230	1	16	6	75	740	200	-	RVS	Corsair EGO EGO Elframo Emmepi Lincat Öztiryakiler Repagas	47-003 56.10549.500 56.10549.560 00032270 C00926 TH44 6234.00001.16 8500016
1	9690.2253	230	1	16	6	77	1160	210	M9x1	-	Cometto EGO Solymac	COM50069 56.10543.500 P78
1	9690.4783	230	1	16	6	77	2280	210	M9x1	-	EGO	56.10549.530
1	NML	235	1	16	3	155	1100	-	-	-	EGO Lincat	56.10549.570 TH71
1	9690.4782	235	1	16	3	190	1000	640	-	RVS	Anitec CF-Cenedese Cookmax Faba RM-Gastro Star10	072028.1 63.7.0632 402511000 PR70008 402511000 072028.1
1	9690.4407	240	1	16	6	77	700	-	M9x1	-	EGO Falcon	56.10549.580 537300060
1	9690.4408	245	1	16	3,1	155	1130	-	M9x1	-	EGO Fagor Mareno	56.10549.590 12048400 CR1074320
1	9690.4409	245	1	16	6	78	700	-	M9x1	-	EGO Falcon	56.10549.591 535770070
1	9690.4410	245	1	16	6	78	750	-	M9x1	-	EGO Falcon	56.10549.591 535670017
1	9690.2318	260	1	16	6	77	860	-	-	RVS	EGO	56.10552.500
1	9690.2280	340	1	16	4	100	1860	1710	-	-	EGO Küppersbusch	56.10569.500 152432
1	9690.2341	350	1	16	3,03	138	1760	1710	-	RVS	EGO TurboChef	56.10565.500 R7603
1	ARA130326	365	1	16	4	96	1160	1100	-	-	EGO Fagor Krefft Rational	56.10573.500 12029569 76-30140326 3014.0326
2	9690.4411	230	1	0,5	6	77	700	-	M9x1	-	Falcon	731310135
2	9690.4784	360	1	16	4	102	1200	820	1/4"	RVS	EGO Rational	56.10573.550 3014.0324

Tabel wordt vervolgd op de volgende pagina



afb.	bestelnr.	T.uit (°C)	aantal polig (-polig)	SC (A)	voeler ø (mm)	voeler L (mm)	cap. (mm)	capillaire pijp geïsoleerd (mm)	stopbus	voeler	passend voor	fabrikantr.
3	9690.2254	320	1	16	4	100	1760	1600	-	-	Bonnet EGO Falcon FriFri Hobart Thirode	301066 56.10555.500 56.10562.500 737600711 601275 301066 301039
3	9690.4429	360		16	3	160	1800	1520	-	-	Blue Seal EGO	025400 56.10565.510
4	9690.2342	360	1	16	15	6,5	1140	1100	-	-	EGO Eloma Palux	56.10573.510 EL0504602 504602
5	9406.7990	365	1	16	4	96	1160	1100	-	RVS	EGO Fagor Rational	56.10573.520 12028972 40.01.482

toebehoren

afb.	bestelnr.	toepassing	G	passend voor	fabrikantr.
1	9690.2600	voor maximaal thermostaat	M8x1	EGO Electrolux	00.00525.020 0A2187
1	ABJ083253	voor maximaal thermostaat	M10x0,75	EGO	00.00525.015

regelthermostaten met voorzetschakelaar

serie 51\_

pos.	bestelnr.	t.ber. (°C)	aantal polig (-polig)	functie	SC (A)	voeler ø (mm)	voeler L (mm)	cap. (mm)	capillaire pijp geïsoleerd (mm)	as L (mm)	passend voor	fabrikantr.
1	9690.4430	45-265	1	1NO	15	3	219	900	-	23	Angelo-Po EGO	32Z0500 51.43918.410



serie 55.10/19\_



afb.	bestelnr.	t.ber. (°C)	aantal polig (-polig)	functie	SC (A)	voeler ø (mm)	voeler L (mm)	cap. (mm)	capillaire pijp geïsoleerd (mm)	stopbus	as L (mm)	passend voor	fabrikantr.
1	9690.2322	50-310	1	1NO	16	4	128	1500	1500	-	23	Angelo-Po EGO	32V6510 55.19662.804
1	9690.4427	30-110	1	1NC	16	6	130	2000	1920	-	23	Ambach	5061603162
1	9690.4428	30-110	1	1NO	16	6	129	870	850	-	23	Ambach EGO	5061608580 55.19622.010
1	9315.0255	105-185	1	1NO	16	6	130	900	700	M10x1	23	Angelo-Po EGO EGO EGO	32V0240 55.19032.831 55.19932.802 PO98311705
1	9998.4967	53-180	1	1NO	16	6	133	1170	1000	-	23	Baron Cookmax EGO EGO Mareno	1037317300 1037317300 55.10633.800 55.19639.020 MA1037317300
1	9162.9770	55-260	1	1NO	16	4	116	1300	1300	-	23	EGO EGO Electrolux Zanussi	55.10659.800 55.19659.010 002109 002109
1	9700.0810	58-183	1	1NO	0,5	4	116	900	700	-	23	EGO EGO EGO Mareno Rosinox Silko	5510632800 55.10632.801 55.19632.030 MACM097800 RX94812560 MACM097800
1	9162.1756	90-185	1	1NO	15	4	229	2500	1200/200	-	23	Bartscher EGO EGO Electrolux Juno Therma Zanussi	049672 55.10639.800 55.19639.800 052330 052330 052330 052330
2	9162.1474	30-90	1	1CO	16	6	173	980	980	-	23	Baron Cookmax EGO EGO Electrolux GIGA Morice	41826630230 41826630230 55.10719.800 55.19619.030 051142 X57800 DE0426
2	9690.4785	100-350	1	1NO	16	3	145	900	800	-	25	EGO Mareno Silko	55.19662.010 CR0581280 CR0581280
2	9690.4786	37-110	1	1NO	16	6	129	570	-	-	23	EGO Jünger	55.19629.010 422100
2	9162.3356	91-185	1	1NO	0,5	4	235	2420	1200	-	23	EGO Electrolux	55.19639.030 002602
2	9690.4426	96-180	1	1NO	16	6	133	2420	-	-	23	EGO	55.19639.050
2	9690.2211	99-185	1	1NO	0,5	4	235	870	700	-	23	EGO EGO Lainox Mareno Silko	55.19632.040 97.55196.004 SIR0109170 CR0589660 CR0589660
3	9130.0312	57-320	1	1NO	16	3,1	226	870	800	-	23	Ambach	5061602948



Serie 55.13\_

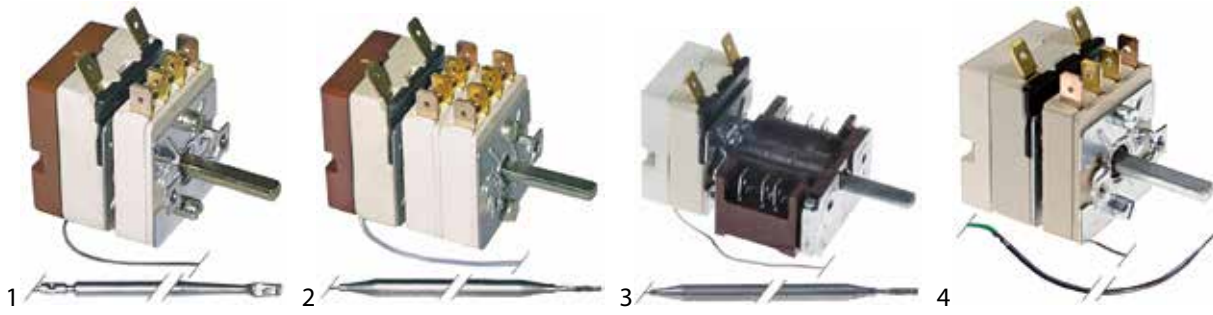

afb.	bestelnr.	t.ber. (°C)	aantal polig (-polig)	functie	SC (A)	voeler ø (mm)	voeler L (mm)	cap. (mm)	capillaire pijp geïsoleerd (mm)	as L (mm)	passend voor	fabrikantnr.
1	9690.4431	30-90	1	1CO	16	6	98	2380	1700	18	Ascobloc EGO	09/3501 55.13619.210
1	9690.0680	30-110	1	1CO	16	6	113	2380	1700	18	Ascobloc Capito EGO EGO Franke Köhler Esback Krefft Küppersbusch Nayati Salvis	9295433 63892 55.13624.020 55.13629.050 1G873027 3000367 49-355693 355693 PD412B 1G873027
1	9690.4435	30-110	1	1NO	15	6	115	900	810	23	Angelo-Po EGO	32Z9271 55.13622.160
1	9690.4432	120-190	1	1NO	16	3	248	1730	1660	23	EGO Franke Nayati Salvis	55.13635.020 1G962531 PD412E 1G962531
1	9690.4430	130-400	1	1NO	16	3,9	163	830	350	23	EGO	55.13672.020
1	9998.1975	140-195	1	1NO	16	6	77	830	500	23	EGO MKN	55.13632.030 203481
1	9690.4445	30-128	1	1NO	16	3,03	178	870	800	23	EGO	55.13622.120
1	9565.0006	30-80	1	1NO	16	6	115	1430	-	23	Blanco EGO	105126 55.13614.070
1	9690.4436	50-320	1	1CO	16	3,03	160	1300	1230	23	Ascobloc EGO	09/2085 55.13669.030
1	9690.4437	50-320	1	1NO	16	3	160	870	-	23	EGO Falcon Lincat	55.13662.070 731050004 —
1	9690.4586	50-320	1	1NO	16	3,03	160	1150	-	23	Ascobloc Cookmax EGO Franke Krefft Küppersbusch Nayati Salvis	9295400 PD412C 55.13663.010 178855 49-174677 174677 PD412C 1G873056
1	9690.4438	50-320	1	1NO	16	3,03	160	1470	350	23	Blue Seal EGO	017121/51 55.13664.060
1	9690.0112	50-320	1	1NO	16	3,03	160	3150	-	23	EGO	55.13669.050
1	9690.4440	60-250	1	1NO	16	4	100	3150	3090	23	EGO Rational	55.13649.010 3014.0308
1	9998.5282	95-210	1	1NO	16	3,1	201	1770	1600	23	EGO Küppersbusch	55.13645.010 152107
1	9998.1675	97-185	1	1CO	16	6	87	2380	700	23	EGO	55.13639.030
2	9690.0680	30-110	1	1NO	16	6	113	830	800	23	EGO Electrolux Therma	55.13622.080 OK5023 OK5023
3	9690.4442	30-110	1	1NO	16	6	113	1430	-	23	EGO EGO Köhler Esback	55.13924.010 55.13924.020 3000368, 392080
3	9690.4443	50-291	1	1NO	16	3	160	980	600	25	EGO Falcon	55.13059.180 735400230
3	9690.4444	50-291	1	1NO	16	3	160	980	600	25	EGO Falcon	55.13059.180 732910090
4	9690.4441	30-105	1	1NO	16	3,03	178	870	800	23	EGO	55.13622.140



## serie 55.34\_

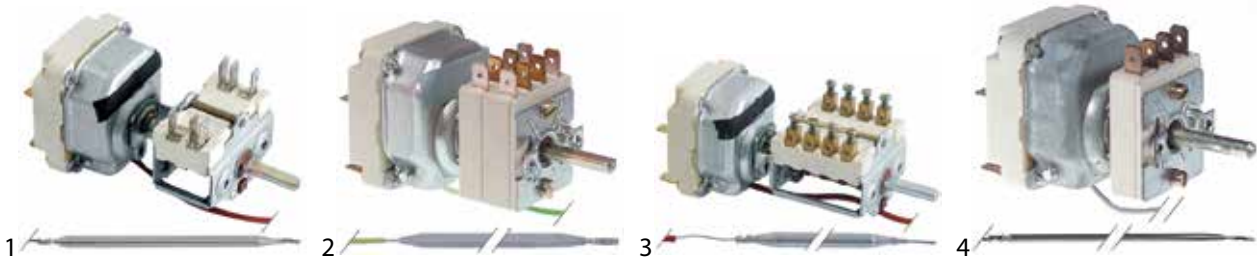

afb.	bestelnr.	t.ber. (°C)	aantal polig (-polig)	functie	SC (A)	voeler ø (mm)	voeler L (mm)	cap. (mm)	capillaire pijp geïsoleerd (mm)	as L (mm)	passend voor	fabrikantnr.
1	9690.4787	30-110	3	3NO	16	6	130	1200	1200	23	Angelo-Po	32V0060
1	9690.4788	30-85	3	3NO	16	6	131	1440	-	23	Stahl	162015
1	9690.4525	60-330	2	2NO	16	4	128	1500	1450	23	Angelo-Po EGO EGO	32V0661 55.34064.805 55.34964.800
2	9998.1735	100-180	3	3NO	16	6	133	1780	1600	23	EGO	55.34635.010
2	9690.4446	0-180	3	3NO	-	6	130	1740	1310	23	Berner EGO	400300 55.34635.020
2	9191.0076	103-175/108-180	3	2NO/2NO	16	3,1	305	720	700	23	EGO Küppersbusch Palux	55.34639.010 540511 026611
2	9690.2288	32-110	3	3NO	16	6	138	1180	1100	23	EGO Küppersbusch Palux	55.34613.010 540592 700509
2	9690.2264	43-300	4	4NO	16	6	77	1480	1350	23	EGO EGO	55.34654.010 55.40654.010
2	9690.4447	56-306	3	3NO	16	6	77	1590	1400	23	Berner EGO	500301 55.34669.103
2	9690.2309	60-390	3	3NO	16	3,9	228	1110	600/700	23	EGO Palux	55.34673.010 619248
2	9191.0385	70-255	3	3NO	16	4	128	880	880	23	EGO Palux	55.34642.010 631981
2	9690.2276	77-300	3	3NO	16	4	128	880	800	33	EGO Palux	55.34652.010 606227
3	9690.4789	100-300	3	3NO	16	6	75	1150	1150	23	Angelo-Po	32Z3790
3	9690.4790	100-530	3	3NO	16	3,9	228	1110	1000	23	Electrolux Juno Therma	0G2529 0G2529 0G2529
4	9690.2308	50-300	3	3NO	16	3,03	160	1480	350	24	EGO Nayati	55.34654.020 SS2028
4	9690.2286	100-470	1	1NO	16	3,9	228	1110	600	24	EGO Electrolux Franke Juno Rational Salvis	55.34683.040 0K0662 179312 0K0662 40.00.799 179312
4	9690.2205	50°C/50-600°C/70-650	3	3NO	16	4	228	1200	1200	23	Ambach Baron EGO Franke Mareno MKN Nayati Palux Salvis Silko	5061610558 CR0688650 55.34683.800 179302 21351299 203408 PD.412K 661635 179302 CR0688650

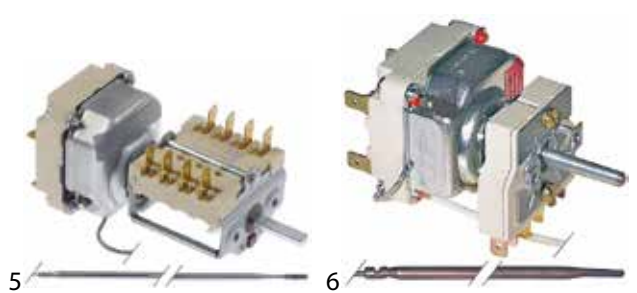

afb.	bestelnr.	t.ber. (°C)	aantal polig (-polig)	functie	SC (A)	voeler ø (mm)	voeler L (mm)	cap. (mm)	capillaire pijp geïsoleerd (mm)	as L (mm)	passend voor	fabrikantnr.
5	9163.4560	50-300	3	3NO	16	4	292	2300	2260	25,5	EGO Electrolux Therma	55.34059.080 0K5022 077018015428
6	9690.4448	100-615/645	2	2NO	16	4	230	1100	600	25	EGO Electrolux EKU Electrolux Juno Lohberger MKN Morice Rosinox Solymac	55.34683.010 55.34683.050 3-22 0K0496 0K0496 51440169 203408 DE0254 RX94090032 P709

IMIT / TEMPOMATIC / ARTHERMO

regelthermostaten

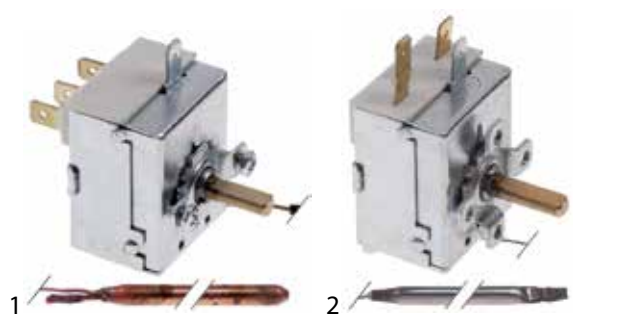

afb.	bestelnr.	t.ber. (°C)	aantal polig (-polig)	functie	SC (A)	voeler ø (mm)	voeler L (mm)	cap. (mm)	capillaire pijp geïsoleerd (mm)	as L (mm)	passend voor	fabrikantnr.
1	9691.0058	-	1	1CO	16	3	200	1540	-	19	VEMA	XRPV3
1	9451.0555	0-90	1	1CO	16	6,5	95	2000	2000	19	Dihl Hoonved Kromo Mach Rhima	DW10707/2 25417 DW10707/2 500000100 10707/2
1	9691.0056	0-90	1	1CO	16	6,5	98	1030	970	16	Univer-Bar	4044
1	9450.0285	40-78 / 47-85	2	2CO	16	6,5	95	1500	1450	15	Comenda Hoonved Mareno	120525 H120525 120525
2	9450.0285	-	1	1CO	16	6,5	110	1500	1450	19	ATA Camurri	1080 neu 050B0231
2	9691.0020	-	1	NC	16	7	90	150	-	23	La-Spaziale	11168
2	9000.0480	30-90	1	1CO	15	6	90	1500	1400	15	Forved Teikos	VETRTERMOST 843630
2	9691.0000	30-90	1	1CO	15	6,5	95	1000	-	19	Rancilio	34200051
2	9691.0005	265	1	1NO	15	4	90	900	20	18	Cookmax Sirman	IGS704203 IGS704203
2	9691.0010	50-300	1	1CO	15	4	97	900	-	19	Amitek Sirman	R00221 IB5866400
2	9691.0050	0-200	1	1CO	16	5	98	1040	-	20	Cooking-Systems	C5322059
2	9691.0024	0-85	1	1CO	15	6	78	1000	-	15	Cookmax Hatco	X02.16.136.00 X02.16.136.00

Tabel wordt vervolgd op de volgende pagina



afb.	bestelnr.	t.ber. (°C)	aantal polig (-polig)	functie	SC (A)	voeler ø (mm)	voeler L (mm)	cap. (mm)	capillaire pijp geïsoleerd (mm)	as L (mm)	passend voor	fabrikantnr.
2	9162.3556	0-86	1	1CO	16	6,5	95	1500	-	19	Angelo-Po Anitec ATA Bartscher CF-Cenedese Classeq Colged Comenda Dexion Elettrobar GIGA Hoonved Lasa Mareno MBM-Italia NuovaSimonelli OEM Palux Sammic Silanos Star10	32V1910 072029 7280 0929044 63.7.0658 30007713 DRT11 120501 014688-00 929044 SD907110 H120501 3264000 120501 014688-00 18010043 ED00100 208418 2309068 907100 072029
2	NML	0-86	1	1CO	16	6,5	97	1500	-	18	Dihr Hemerson Kromo Luxia	DW10707/1 041001 DW10707/1 L2060old
2	9691.0022	0-86	1	1CO	16	6,5	98	1000	960	20	Silanos	TR0440
2	9450.0570	0-90	1	1CO	10	6,5	97	1000	950	12	Comenda Hoonved Krefft	120515 120515 63-120515
2	9691.0026	0-90	1	1CO	15	6,5	85	1000	900	19	Acopa VEGA	10020 93001
2	9691.0030	0-90	1	1CO	15	6,5	100	1500	-	18	Astoria Cookmax Sirman VEMA	20314 IV5863500 IV5863500 XRCU20
2	9998.1810	27-87	1	1CO	15	6,5	95	1000	1000	19	Elframo Kommel	00057150 00057150
2	9691.0032	30-120	1	1CO	15	6,5	95	1000	1000	19	Forved	VETRTER120
2	9998.5385	40-120	1	1CO	16	6,5	95	1000	-	19	Bertos Camurri	24064000 050B0230
2	9998.2400	56-310	1	1CO	16	3,5	195	1000	-	19	—	—
2	9998.5295	64-210	1	1CO	16	5	100	1000	-	19	Dexion MBM-Italia	019310-00 019310-00
3	9451.2570	30-90	1	1CO	16	6,5	95	2000	1950	-	Dihr Kromo Lamber Olis Rhima Rosinox WEGA	DW10707/1 DW10707/1 0300005 10707/1 DR50 RX94807732 WY3DD107071
3	9691.0028	0-90	1	1CO	15	6,5	95	1500	1440	-	Project	30510
3	9691.0034	0-90	1	1CO	16	6,5	95	1500	1500	-	Angelo-Po Hoonved Rosinox	32V1920 25421 RX94801099
4	9450.0420	30-90	1	1CO	16	9,5	50	1000	1000	19	Comenda Hoonved Mareno	120522 H120522 120522
5	99987.0036	30-90	1	1NC	16	6	98	900	-	18	Inomak	34500040100152



afb.	bestelnr.	t.ber. (°C)	aantal polig (-polig)	functie	SC (A)	voeler ø (mm)	voeler L (mm)	cap. (mm)	capillaire pijp geïsoleerd (mm)	as L (mm)	passend voor	fabrikantnr.
6	9691.0038 <sup>1</sup>	40-210	1	1CO	16	5	128	930	-	20	Silanos	TR0441
6	9998.6199	0-90	1	1CO	15	6,5	100	3000	3000	-	GAM Krupps	KR103345 103345
6	9451.0570	0-90	1	1CO	16	6,5	95	1500	1450	-	Angelo-Po Aristarco ATA Bartscher Bonnet Colged Dihl EGO Elettrobar Fabar Kromo Krupps Modular Rhima Rosinox	32Z7200 00000359 7608 0236027 5508E DRT13B DW15621 51.11999.160 929107 14197 DW15621 359 461.016.00 929107 RX94803103
6	9691.0070	0-90	1	1CO	16	6,5	110	1000	950	19	NuovaSimonelli Omniwash Rancilio	18010043 CETB85 34200047
6	9691.0335	vast 52	1	1CO	16	6,5	95	1000	1000	-	Bourgeois NuovaSimonelli OEM Omniwash Palux	REGU010 18010042 ED002 CETV55 208442
6	9691.0062	vast 60	-	1CO	15	6,5	95	2000	1950	-	Bonnet Rosinox Thirode	2001895H RX94803095 2001895H
6	9691.0060	vast 87	1	1CO	16	6,5	97	1500	-	-	Comenda Rosinox	120530 RX94807732
7	9691.0340	0-87	1	1CO	16	6,5	97	1500	1400	-	Luxia	L2060
8	9690.4431	0-90	1	1CO	15	6	104	1400	1350	18	Bertos Metalcarrelli	22062400 003201820001
9	9691.0066	0-90	1	1CO	15	11	36	600	550	19	CF-Cenedese Tecnoinox	63.7.0655 RC00238000
9	9998.5603	0-90	1	1CO	15	11	36	600	600	19	Offcar	843791
9	9691.0052	25-85	1	1CO	15	11	35	600	600	8	Electrolux Elettrobar MBM-Italia Rancilio Zanussi	069423 236014 236014 65236014 069423

<sup>1</sup>incl. knop

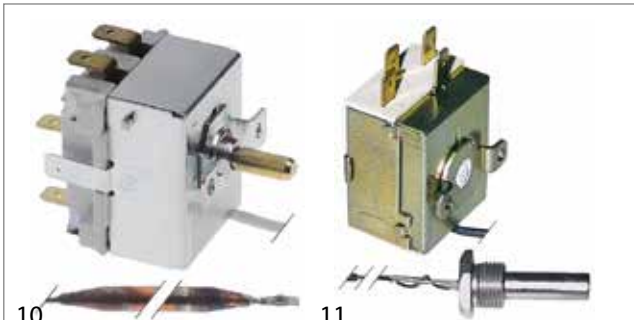
afb.	bestelnr.	t.ber. (°C)	aantal polig (-polig)	functie	SC (A)	voeler ø (mm)	voeler L (mm)	cap. (mm)	capillaire pijp geïsoleerd (mm)	as L (mm)	passend voor	fabrikantnr.
10	9691.0048	37-76 / 46-85	2	2CO	16	6,5	84	920	845	15	Hoonved	120525/1
11	9451.0370	vast 55	1	1CO	16	9,5	37	600	540	-	Angelo-Po Capic Rhima Silanos Whirlpool	32V2630 L455065 236042 907124 483286008151
11	9691.0040	vast 55	1	1CO	16	11	22	600	600	—	—	—
11	9691.0042	vast 60	1	1CO	16	9,5	37	600	600	-	Bonnet Elettrobar Rosinox	5868E DRT141C RX94803129

## regelthermostaten met voorzetschakelaar



afb.	bestelnr.	t.max. (°C)	t.ber. (°C)	aantal polig (-polig)	functie	SC (A)	voeler ø (mm)	voeler L (mm)	cap. (mm)	capillaire pijp geïsoleerd (mm)	stopbus	as L (mm)	passend voor	fabrikantnr.
1	9998.2615	270	63-270	1	1CO	15	3,5	195	1000	-	-	17	Bertos Fimar Sirman	30064600 CO4421 IGS460
1	9691.0044	300	67-300	1	1CO	16	3,5	197	900	-	-	26	Aristarco	00003350
1	9691.0044	300	76-300	1	1CO	16	3	195	1030	250	-	26	Aristarco	00003470



maximaal thermostaten

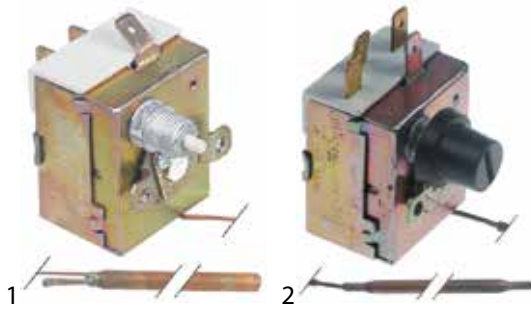

afb.	bestelnr.	T.uit (°C)	aantal polig (-polig)	SC (A)	voeler ø (mm)	voeler L (mm)	cap. (mm)	capillaire pijp geïsoleerd (mm)	stopbus	voeler	passend voor	fabrikantnr.
1	9691.0080	120	1	16	6,5	93	1500	1440	-	-	Lasa	3267100
1	9691.0082	90-110	1	16	6,5	90	2000	1950	-	-	Lamber	0300196
2	9450.1250	135	1	16	5	130	1000	900	-	-	Comenda Hoonved Mareno	120519 H120519 120519
2	9993.6444	140	1	15	5	125	1000	900	-	-	Modular Multi	461.071.00 150026
2	NML	238	1	0,5	5	100	1050	-	-	RVS	Angelo-Po	32V4750
2	9691.0086	238	1	15	5	100	550	-	-	RVS	Forved Star10	9004 072028.1
2	9998.5366	90-110	1	16	6,5	90	1000	-	-	-	Angelo-Po Fabar GIGA Rosinox Silanos	32Z8830 14197A SD907125 RX94813555 907125
2	9691.0088	90-110	1	16/0,5	6,5	90	2000	1950	-	-	ATA Bonnet Colged Elettrobar Rosinox Thirode	13121 2002136H 927057 927057 RX94803137 2002136H

CAEM

regelthermostaten

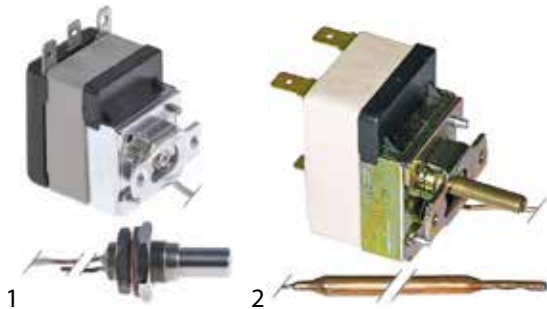

afb.	bestelnr.	t.max. (°C)	t.ber. (°C)	aantal polig (-polig)	functie	SC (A)	voeler ø (mm)	voeler L (mm)	cap. (mm)	capillaire pijp geïsoleerd (mm)	stopbus	as L (mm)	passend voor	fabrikantnr.
1	9998.0150	53	vast 53	1	1CO	16	9,5	30	600	540	-	-	Colged Cookmax Hobart Krefft Marels MBM-Italia Modular Rancilio	236042 236042 E236042 62-236042 46101500 236042 46101500 65236042
2	9691.0072	90	30-90	1	1CO	16	6	95	1600	1550	-	-	Inoxtrend	C2185-00
2	9691.0074	100	30-90	1	1CO	16	6	94	1600	-	-	22	Cookmax Emmepi RM-Gastro	40250110 807256 40250110
2	9691.0076	100	30-120	1	1CO	16	6	110	1600	1550	-	22	Bertos	25064500
2	9998.2790	110	30-110	1	1CO	16	6	75	1600	-	-	22	Bertos Emmepi	31290500 828838

Tabel wordt vervolgd op de volgende pagina



afb.	bestelnr.	t.max. (°C)	t.ber. (°C)	aantal polig (-polig)	functie	SC (A)	voeler ø (mm)	voeler L (mm)	cap. (mm)	capillaire pijp geïsoleerd (mm)	stopbus	as L (mm)	passend voor	fabrikantnr.
3	9691.0092	120	30-120	1	1NO	16	5	80	980	28	-	17	Cookmax RM-Gastro	402501501 402501501
3	9691.0090	190	50-190	1	1NO	16	3	185	980	640	-	23	Cookmax RM-Gastro	402502000 402502000
3	9137.0015	300	50-300	1	1NO	16	3	200	1500	650	-	18	Cookmax RM-Gastro	402503150 402503150
3	9998.5604	300	50-300	1	1NO	16	5	80	970	650	-	18	Bartscher Cookmax RM-Gastro	A0402503000 402503000 402503000
3	9691.0096	300	50-280	1	1NO	16	3	160	1450	650	-	22	Bake-Off Bakers Pride	182500044 182500044

## maximaal thermostaten

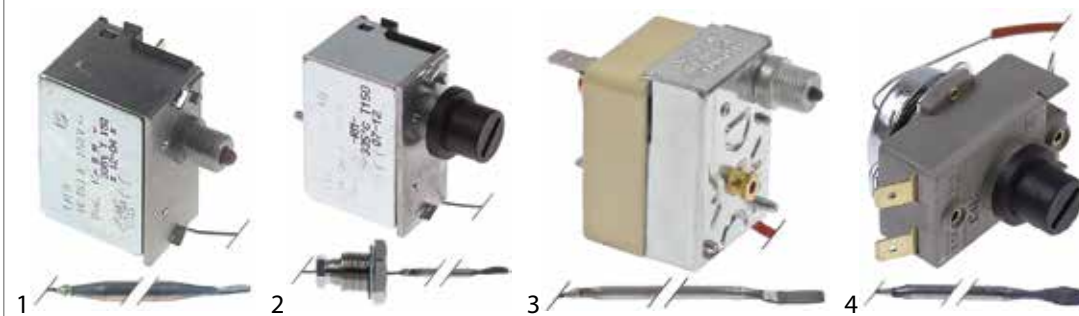

afb.	bestelnr.	T.uit (°C)	aantal polig (-polig)	SC (A)	voeler ø (mm)	voeler L (mm)	cap. (mm)	capillaire pijp geïsoleerd (mm)	stopbus	voeler	passend voor	fabrikantnr.
1	9691.0110	95	1	16	6	80	1550	-	-	RVS	Ascobloc	09/3585
1	9691.0112	123	1	16	3	200	920	770	-	RVS	MBM-Italia	RTFOC00173
1	9691.0108	130	1	16	5	120	900	-	-	RVS	Cookmax RM-Gastro	402511130 402511130
1	9691.0100	335	1	16	5	80	900	-	-	RVS	Tecnoeka	01201190
2	9691.0104	225	1	16	5	80	900	400	M10x1	RVS	Bourgeois Solymac	THER3004 P1006
2	9691.0102	225	1	16	5	80	900	410	M10	RVS	MBM-Italia	RIC0004363
3	9882.0045	335	1	16	3	180	970	780	-	RVS	Bake-Off	182500035
4	9281.0247	335	2	20	3	200	1050	650	-	RVS	Cookmax Sogeco Tecnoeka Unox	TR254 03-TRS-350 01200400 KTR1134A



afb.	bestelnr.	T.uit (°C)	aantal polig (-polig)	SC (A)	voeler ø (mm)	voeler L (mm)	cap. (mm)	capillaire pijp geïsoleerd (mm)	stopbus	voeler	passend voor	fabrikantnr.
5	9691.0098	350	1	16	6	78	900	650	M10x1	RVS	MBM-Italia	177060

JUMO

regelthermostaten

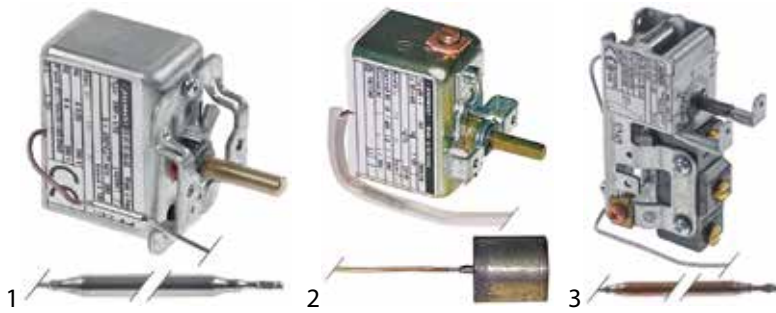

afb.	bestelnr.	t.max. (°C)	t.ber. (°C)	aantal polig (-polig)	functie	SC (A)	voeler ø (mm)	voeler L (mm)	cap. (mm)	capillaire pijp geïsoleerd (mm)	stopbus	as L (mm)	passend voor	fabrikantnr.
1	9393.2115	200	0-200	1	1CO	6	6	114	1000	-	-	13	Rosinox	RX94016573
1	9393.2165	300	50-300	1	1CO	16	6	85	1000	-	-	19	—	—
1	9691.0120	500	20-500	1	1CO	16	8	155	1000	-	-	17	Pizza-Group	5320470
1	9691.0122	500	20-500	3	3CO	16	8	155	1000	-	-	17	GGF Pizza-Group Tornati	thermo003 A88TX85003 333003
1	Op aanvraag	400	20-400	1	1CO	6	8	138	1450	-	-	18	Rosinox	RX94016581
2	9691.0345	440	20-440	3	3CO	10	20	21	1000	900	-	17	Ambach	5061614400
2	9998.5865	440	20-500	1	1CO	10	20	21	1000	900	-	17	Ambach	5061608296
3	9691.0350 <sup>1</sup>	500	20-500	1	1CO	10	6	125	1500	-	-	16	MIWE	504016.02

<sup>1</sup>met toebehoren

maximaal thermostaten

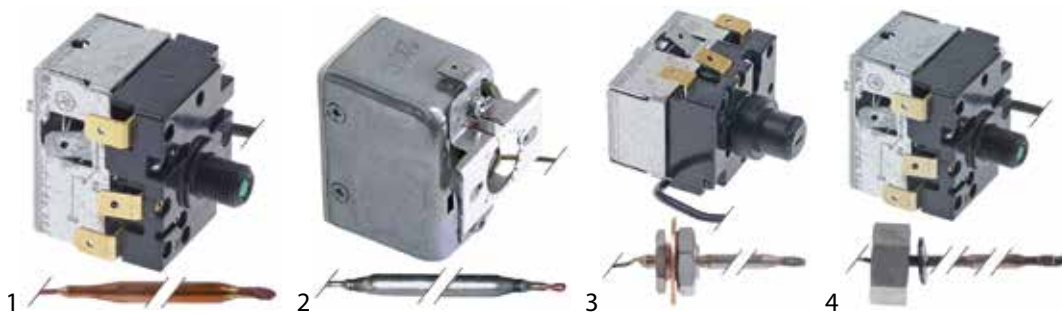

afb.	bestelnr.	T.uit (°C)	aantal polig (-polig)	SC (A)	voeler ø (mm)	voeler L (mm)	cap. (mm)	capillaire pijp geïsoleerd (mm)	stopbus	voeler	passend voor	fabrikantnr.
1	9691.0124	140	1	16	5	96	990	880	-	koper	Retigo	EA04-0011
1	9691.0125	95-120	1	16	6	75	2000	450	-	—	—	—
2	9691.0128	50-300	1	16	6	85	1000	-	-	RVS	—	—
2	9691.0130	0-150	1	16	6	116	1000	-	-	—	—	—
2	9998.2755	20-500	1	16	8	155	1000	-	-	—	CB	09010020
3	9691.0132	350	1	2,5	5	48	950	500	-	RVS	Hounö	30820046
4	9691.0134	365	1	16	4	107	1190	1015	-	—	Retigo	EA04-0012



afb.	bestelnr.	T.uit (°C)	aantal polig (-polig)	SC (A)	voeler ø (mm)	voeler L (mm)	cap. (mm)	capillaire pijp geïsoleerd (mm)	stopbus	voeler	passend voor	fabrikantnr.
5	390169	20-500	1	16	6	275	1000	-	-	—	Moretti Tornati	74200260 333007



## TECASA

## regelthermostaten



pos.	bestelnr.	t.max. (°C)	t.ber. (°C)	aantal polig (-polig)	functie	SC (A)	voeler ø (mm)	voeler L (mm)	cap. (mm)	capillaire pijp geïsoleerd (mm)	stopbus	as L (mm)	passend voor	fabrikantnr.
1	9691.0158	55	30-55	1	1NO	16	6	105	880	-	-	16	Roller-Grill	A06049
2	9691.0357	85	30-90	1	1NO	16	6	90	2000	1950	-	23	Fagor	12034068
3	9691.0162	90	30-90	1	1NO	16	6	95	1550	1500	-	16	Öztiryakiler	6234.00001.42
4	9691.0164	95	0-95	1	1NO	16	6	105	900	-	-	16	Roller-Grill	A06021
5	9691.0166	110	30-110	1	1CO	16	6	91	880	850	-	18	Öztiryakiler	6234.00001.080
6	9691.0168	170	50-170	1	1NO	16	6	75	420	210	-	15	Roller-Grill	A06018
7	9691.0170	180	50-180	1	1NO	16	5	90	620	290	-	16	Fiamma	4.0.085.0009
8	9691.0172	190	50-190	1	1NO	16	3	145	880	680	-	-	CF-Cenedese	63.7.0640
9	9690.2258	190	60-190	1	1NO	16	6	70	2000	490	-	23	Öztiryakiler	6234.00001.40
10	9691.0174	230	45-230	1	1NO	16	3,1	150	530	-	-	14	Roller-Grill	A06019
11	9691.0176	280	30-280	1	1NO	16	3	170	860	-	-	14	Roller-Grill	A06032
12	9691.0182	300	50-300	1	1NO	16	3	165	870	-	-	23	Öztiryakiler	6234.00001.05

## maximaal thermostaten



pos.	bestelnr.	T.uit (°C)	aantal polig (-polig)	SC (A)	voeler ø (mm)	voeler L (mm)	cap. (mm)	capillaire pijp geïsoleerd (mm)	stopbus	voeler	passend voor	fabrikantnr.
1	9395.0287	125	1	16	6	73	870	690	M9x1	RVS	Fagor	12023830
2	9691.0184	230	1	16	3	155	890	600	-	RVS	Bertos CF-Cenedese VEGA	33070300 63.7.0630 93037
3	9691.0186	230	1	16	6	52	520	70	-	RVS	Roller-Grill	A06001
4	9691.0188	230	1	16	6	58	2000	490	-	RVS	Öztiryakiler	6234.00001.41
5	9691.0190	235	1	16	5	73	1030	600	-	RVS	Fiamma	4.0.085.0011
6	9691.0192	240	1	16	4	84	400	130	-	RVS	Acopa Amitek Fimar VEGA	10030 R00109 CO1110 93180
7	9993.0412	335	1	16	3	120	1500	-	M9x1	RVS	Garbin	TER021





CAMPINI

regelthermostaten



afb.	bestelnr.	t.max. (°C)	t.ber. (°C)	aantal polig (-polig)	functie	SC (A)	voeler ø (mm)	voeler L (mm)	cap. (mm)	capillaire pijp geïsoleerd (mm)	stopbus	as L (mm)
1	9691.0144	90	0-90	1	1CO	16	6,5	87	1470	1450	-	-
2	9342.1065	124	-	1	1CO	16	6	70	1970	1970	-	-
3	9191.0148	270	50-270	1	-	-	3	135	1450	-	-	-
3	9691.0150	280	50-280	1	1NO	16	3	185	960	700	-	23
3	9691.0146	292	50-292	1	1NO	16	3	170	970	970	-	33

maximaal thermostaten



afb.	bestelnr.	T.uit (°C)	aantal polig (-polig)	SC (A)	voeler ø (mm)	voeler L (mm)	cap. (mm)	capillaire pijp geïsoleerd (mm)	stopbus	voeler
1	9281.1020	318	1	16	3	137	1260	710	-	RVS

COTHERM



afb.	bestelnr.	t.max. (°C)	t.ber. (°C)	aantal polig (-polig)	functie	SC (A)	voeler ø (mm)	voeler L (mm)	cap. (mm)	capillaire pijp geïsoleerd (mm)	stopbus	as L (mm)	passend voor	fabrikantr.
1	9691.0156	-	-	1	1NC	25	3	130	1720	-	-	-	Bourgeois	THER014
2	9108.2185	106	-	1	1NC	20	2,3	10	300	-	-	-	Animo	02929
3	9691.0355	300	35-300	1	1NO	20	3	180	1000	-	-	16	Simogas	ELP-30.17



## INVENSYS / ROBERTSHAW

## regelthermostaten



afb.	bestelnr.	t.max. (°C)	t.ber. (°C)	aantal polig (-polig)	functie	SC (A)	voeler ø (mm)	voeler L (mm)	cap. (mm)	capillaire pijp geïsoleerd (mm)	stopbus	as L (mm)	passend voor	fabrikantr.
1	9765.0235	121	15,5-121	1	1NO	-	8,4	98	1130	-	-	20	Henny-Penny Robertshaw	50016 5300-04A
2	9691.0360	142	0-142	1	1NO	25	13	230	1200	-	3/8" NPT	24	Falcon Robertshaw	736009730 K-153-48
3	9765.0240	190	90-190	1	1NO	0,67	9,5	95	900	-	1/4"	23	Falcon Robertshaw	535710029 RX-19-36
3	9765.0245	190,6	93-190	1	1NO	0,67	9,5	120	870	-	3/8" NPT	23	Pitco	60125402
3	9765.0255	287	93-287	1	1NO	30	4,6	290	1200	-	-	23	Falcon Robertshaw	730962080 EA5P-485-48
3	9765.0260	287	93-287	1	1NO	30	4,7	290	1200	-	-	23	Falcon Robertshaw	731880190 EA5-24-48
4	9765.0265	190	94-190	1	1NO	0,67	9,5	125	900	-	1/4" NPT	23,5	—	—



afb.	bestelnr.	t.max. (°C)	t.ber. (°C)	aantal polig (-polig)	functie	SC (A)	voeler ø (mm)	voeler L (mm)	cap. (mm)	capillaire pijp geïsoleerd (mm)	stopbus	as L (mm)	passend voor	fabrikantr.
5	9765.0270	191		1	1NO	-	8	124	590	-	-	24	Frymaster	8262014
6	9765.0275	204	93-204	1	1NO	-	8	128	570	-	5/16" UNF	20	Henny-Penny Robertshaw	14293 5300-76F
7	9765.0290	204	93-204	1	1NO	0,67	9,5	123	915	-	1/4" NPT	21	American Dryer Anets Franke Frymaster Imperial-Germany Imperial-USA OEM Pitco Robertshaw Tri-Star	A50400 P8905-03 719.390.554 807-3515 1175 1175 P8905-03 60125401 RX-1-36 300232
8	9765.0280	205	94-205	1	1NO	-	9,5	123	885	-	3/8" NPT	-	Pitco Robertshaw	P5047587 EA3-44-36
9	9765.0285	232	12-232	1	1NO	25	6,5	173	870	-	-	20	Garland Robertshaw	G0893-01 K-1139-36
9	9765.0290	314	38-314	1	1NO		5	285	1750	-	-	20	Garland Robertshaw	1611900 KX-410-72



afb.	bestelnr.	t.max. (°C)	t.ber. (°C)	aantal polig (-polig)	functie	SC (A)	voeler ø (mm)	voeler L (mm)	cap. (mm)	capillaire pijp geïsoleerd (mm)	stopbus	as L (mm)	passend voor	fabrikantnr.
10	9765.0200	232	37-232	2	2NO	30	6,5	172	1045			24	Garland Robertshaw	1102703 D1H20420400
11	9765.0205	260	60-260	1	1NO		5	286	900	-	-	20	Blodgett Garland Robertshaw	16536 1032499 5300-76C
12	9765.0210	260	64-260	1	1NO		5	285	1045	-	-	20	Garland Robertshaw	G02902-01 KX-431-42
12	9765.0285	288	65-288	1	1NO		5	286	1010	255	-	20	Garland Robertshaw U.S. Range	G0894-01 5300-17k 1032400
13	9765.0225	260	93-260	1	1NO	-	4,5	310	900	-	-	32,5	Imperial-USA Robertshaw	1160 KXT-466-36
14	9765.0220	288	38-288	2	2NO	30	5	295	1540	-	-	20	Bakers Pride Garland Robertshaw	M1032X 1010300 5000-851
14	9765.0230	371	148-371	2	2NO	30	5	285	1540	-	-	20	Bakers Pride Garland Robertshaw	M1031X 1010304 5000-601

maximaal thermostaten

afb.	bestelnr.	T.uit (°C)	aantal polig (-polig)	SC (A)	voeler ø (mm)	voeler L (mm)	cap. (mm)	capillaire pijp geïsoleerd (mm)	stopbus	voeler	passend voor	fabrikantnr.
1	9765.0295	121	1	-	6,4	136	610	-	1/4" NPT	RVS	Pitco Robertshaw	60070701 LCHBC0240000
1	Op aanvraag 129,5	129,5	1	-	6,3	133	600	-	1/4" NPT	RVS	Falcon	736094161
1	9765.0300	218	1	-	8	77	940	-	1/4" NPT	RVS	Imperial-USA Robertshaw	33497 LCCM210360000
1	9090.0290	224	1	-	6,4	118	790	-	-	RVS	Pitco Robertshaw	PP11010 LCCG70300000
1	9765.0305	232	1	-	6,4	120	760	-	3/8" NPT	RVS	Nayati Pitco Robertshaw	GS.2183 PP10084 LCHM050300000
1	9998.5380	232	1	-	7,9	77	914	-	3/8" NPT	RVS	Imperial-Germany Imperial-USA Robertshaw	1177 1177 LCCM080360000
1	9765.0310	232	1	-	7,93	77	760	-	-	RVS	Franke Pitco Robertshaw Star-Manufacturing	S19.000.067 P5047216 LCH37-030-0000 2T-Z3209
2	9765.0375	218	1	-	4,8	180	630	-	3/8" NPT	RVS	Robertshaw	LCHB80240000



## JAEGER

## regelthermostaten



1

afb.	bestelnr.	t.max. (°C)	t.ber. (°C)	aantal polig (-polig)	functie	SC (A)	voeler ø (mm)	voeler L (mm)	cap. (mm)	capillaire pijp geïsoleerd (mm)	stopbus	as L (mm)	passend voor	fabrikantnr.
1	9987.0038	184	35-188	1	1NO	16	3	165	520	270	-	20	EGO	55.13039.390

## PRODIGY / FIRT

## regelthermostaten



1



2



3



4

afb.	bestelnr.	t.ber. (°C)	aantal polig (-polig)	functie	voeler ø (mm)	voeler L (mm)	cap. (mm)	capillaire pijp geïsoleerd (mm)	passend voor	fabrikantnr.
1	NML	-	1	1CO	6	72	700	-	Vibiemme	ELETTEDOM
1	9987.0032	-35 tot +35			6	110	1500		Zoin	R0470000
2	9998.0034	-	1	1CO	6	110	650	550	Colged Cookmax Elettrobar Hobart Krefft Rancilio	236043 236043 236043 62-236043 65236043
3	9998.0036	-	1	1CO	6,5	90	1700	1500	Vibiemme	ELETTEDOMJU2B
4	9987.0020	30-90			6,5	63	1500		Franke Friulinox	995574 FR995574



5



6

afb.	bestelnr.	t.ber. (°C)	aantal polig (-polig)	functie	voeler ø (mm)	voeler L (mm)	cap. (mm)	capillaire pijp geïsoleerd (mm)	passend voor	fabrikantnr.
5	9987.0025	30-90	1	-	6,5	85	1350	1325	Lamber	0300270
6	9180.0286	30-90	1	1CO	6,5	67	1450	70	—	—
6	9116.0020	30-120	1	1CO	6	105	1480	100	Tecfrigo	A0103



regelthermostaten met voorzetschakelaar

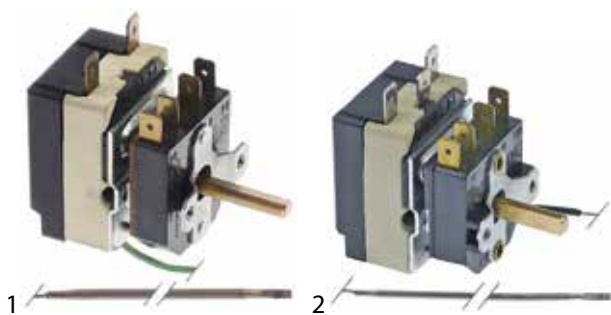

afb.	bestelnr.	t.ber. (°C)	aantal polig (-polig)	functie	SC (A)	voeler ø (mm)	voeler L (mm)	cap. (mm)	capillaire pijp geïsoleerd (mm)	as L (mm)	aspositie (°)	RH (°)	voorzetschakelaar	passend voor	fabrikantnr.
1	9986.3820	50-300	1	1NO	16	3	190	1015	795	24	-	270	2NO	Gierre	TER123
2	9691.0194	63-270	1	1CO	16	3	185	950	55	16,5		270	2NO	CF-Cenedese	63.7.0651

maximaal thermostaten

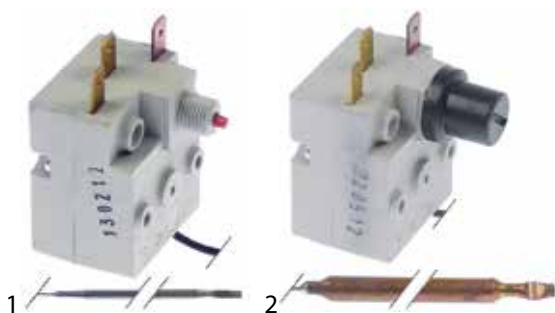

afb.	bestelnr.	T.uit (°C)	aantal polig (-polig)	functie	SC (A)	voeler ø (mm)	voeler L (mm)	cap. (mm)	capillaire pijp geïsoleerd (mm)	stopbus	voeler	passend voor	fabrikantnr.
1	9691.0196	200	1	1CO	20	3,3	190	2150	-	-	RVS	Bartscher Bonnet Capic Thirode	0927106 2001687H L454815 2001687H
2	9691.0198	235	1	1CO	20	6	62	1600	85	-	koper	—	—

RANCO

maximaal thermostaten

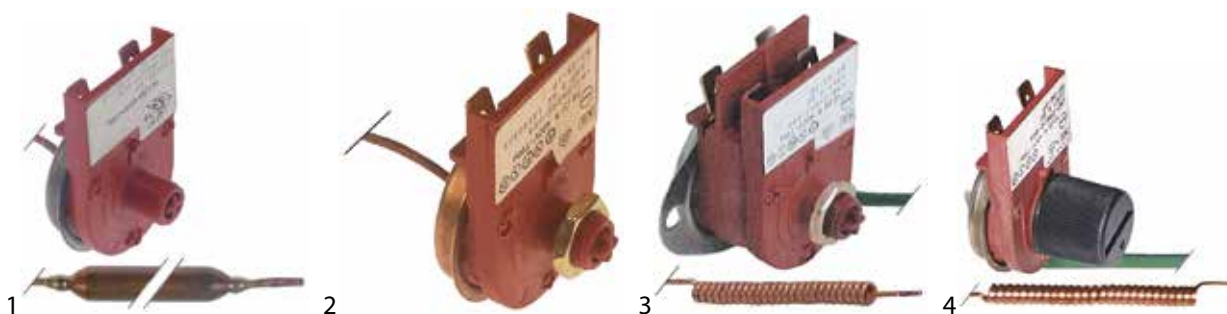

afb.	bestelnr.	t.max. (°C)	t.ber. (°C)	aantal polig (-polig)	functie	SC (A)	voeler ø (mm)	voeler L (mm)	cap. (mm)	capillaire pijp geïsoleerd (mm)	stopbus	as L (mm)
1	9119.0060	70	0-70	1	1NO	16	8	60	870	-	-	-
2	9691.0136	80	-	1	1NC	16	9	50	800	-	-	-
3	9998.6633	105	-	2	2NC	16	6	50	430	310	-	-
4	ABJ083523	110	-	1	1NC	16	6	50	1540	160	-	-

afb.	bestelnr.	t.max. (°C)	t.ber. (°C)	aantal polig (-polig)	functie	SC (A)	voeler ø (mm)	voeler L (mm)	cap. (mm)	capillaire pijp geïsoleerd (mm)	stopbus	as L (mm)
5	9691.0138	110	-	2	2NC	16	6	50	1540	160	-	-
6	9691.0140	165	-	1	1NC	25	2	-	490	-	-	-

## thermostaten

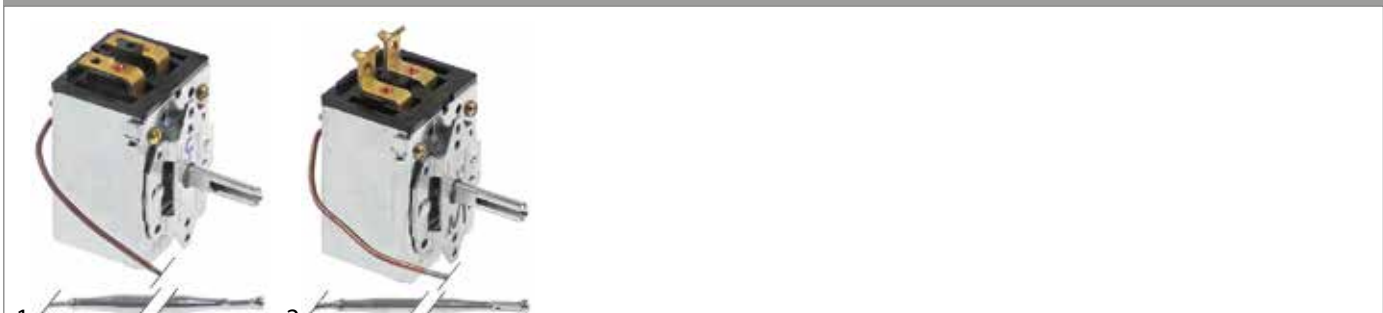

afb.	bestelnr.	t.max. (°C)	t.ber. (°C)	aantal polig (-polig)	functie	SC (A)	voeler ø (mm)	voeler L (mm)	cap. (mm)	capillaire pijp geïsoleerd (mm)	stopbus	as L (mm)
1	Op aanvraag	204	65-204	1	1NO	-	6	165	930	-	-	24
2	Op aanvraag	232	65-232	1	1NO	-	5	324	1540	-	-	24
2	Op aanvraag	260	65-260	1	1NO	-	4,8	320	925	-	-	24

## RATHGEBER

## regelthermostaten

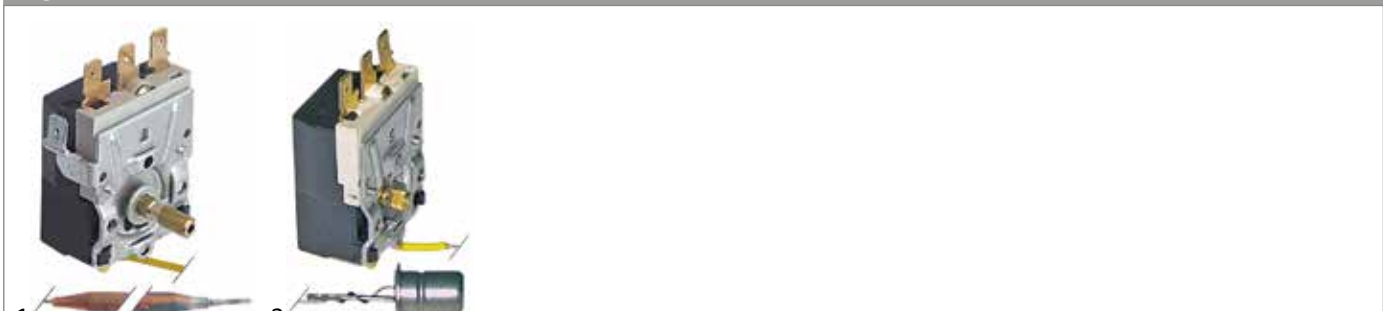

afb.	bestelnr.	t.max. (°C)	t.ber. (°C)	aantal polig (-polig)	functie	SC (A)	voeler ø (mm)	voeler L (mm)	cap. (mm)	capillaire pijp geïsoleerd (mm)	stopbus	as L (mm)	passend voor	fabrikantnr.
1	9775.1640	90	0-90	1	1CO	16	6	140	3000	50	-	-	Meiko	0108041
1	9775.0032	95	0-95	1	1CO	16	6	145	480	430	-	17	Meiko	0108036
1	9775.0855	95	0-95	1	1CO	16	6	150	480	420	-	-	Meiko	0108037
1	9691.0200	95	0-95	1	1CO	16	8	135	880	850	-	-	—	—
1	9805.0008	110	30-110	1	1NO	16	6	140	2400	1700	-	17	Electrolux Rieber	OKA778 33060401
1	9805.0030	110	30-110	1	1NO	16	6	140	1600	1560	-	24	Rieber	33060301
1	9805.0285	150	50-150	1	1CO	16	6	90	1450	700	M9x1	23	EGO Rieber	55.13018.140 33061903
2	9595.0140	95	0-95	1	1CO	16	15	17	450	50	-	-	—	—



regelthermostaten met voorzetschakelaar



afb.	bestelnr.	t.ber. (°C)	aantal polig (-polig)	functie	SC (A)	voeler ø (mm)	voeler L (mm)	cap. (mm)	capillaire pijp geïsoleerd (mm)	as L (mm)	passend voor	fabrikantr.
1	9691.0205	30-110	1	1NC	16	6	140	860	65	26,5	Jünger	422111
1	9691.0210	30-110	1	1NO	16	6	140	1650	1400	17	Rieber	33061801

STIEBEL-ELTRON



afb.	bestelnr.	T.uit (°C)	t.ber. (°C)	aantal polig (-polig)	functie	SC (A)	voeler ø (mm)	voeler L (mm)	cap. (mm)	capillaire pijp geïsoleerd (mm)	stopbus
1	9105.0115	165	-	2	2NC	25	3	340	-	-	-

diversen

regelthermostaten



afb.	bestelnr.	t.max. (°C)	t.ber. (°C)	aantal polig (-polig)	functie	SC (A)	voeler ø (mm)	voeler L (mm)	cap. (mm)	capillaire pijp geïsoleerd (mm)	stopbus	as L (mm)	passend voor	fabrikantr.
1	9691.0215			1	1NO	-	6	110	1445	-	M9x1		Falcon	535670014
1	9691.0215 <sup>1</sup>	190	48-190	1	1NO	-	6	110	1445	-	M9x1	22	Falcon	537350034
2	NML	-	-	1	-	-	-	-	-	-	-	16	Grandimpianti	1020089
3	NML	-	-	1	1NC	-	-	-	-	-	-	17	Silex	05 010 030
4	9691.0202	-	-	1	1NC	10	-	-	-	-	-	30	Bartscher Cookmax	01143566 01143566

<sup>1</sup>met toebehoren

afb.	bestelnr.	t.max. (°C)	t.ber. (°C)	aantal polig (-polig)	functie	SC (A)	voeler ø (mm)	voeler L (mm)	cap. (mm)	capillaire pijp geïsoleerd (mm)	stopbus	as L (mm)	passend voor	fabrikantnr.
5	9691.0275	-	-	1	1NO	5	2	-	750	250	-	12	Horeca-Select	GHR1040-14
6	9691.0230	90	0-90	1	1NO	16	6,5	85	970	-	-	15	Cookmax Sirman	IB5866000 IB5866000
7	9691.0225	95	0-95	1	1NO	6	6	95	550	490	-	23	Horeca-Select	GGC1078-5
8	9691.0235	95	35-95	1	1NO	16	6	68	910	860	-	22	Abner	M113109



afb.	bestelnr.	t.max. (°C)	t.ber. (°C)	aantal polig (-polig)	functie	SC (A)	voeler ø (mm)	voeler L (mm)	cap. (mm)	capillaire pijp geïsoleerd (mm)	stopbus	as L (mm)	passend voor	fabrikantnr.
9	NML	115	20-115	1	1NO	16	4	120	1600	130	-	15	Blanco	105678
10	9691.0245	185	-	2	1NO	16	6	77	1500	-	-	25	Hualing	HDF1108-18
11	9691.0250 <sup>1</sup>	250	100-250	1	1NO	-	4	133	1300	950	-	23	Falcon	531740350
12	9691.0260	320	50-320	1	1NO	15	3	155	1030	100	-	23	Lainox	LAR65070400

<sup>1</sup>met toebehoren

## maximaal thermostaten

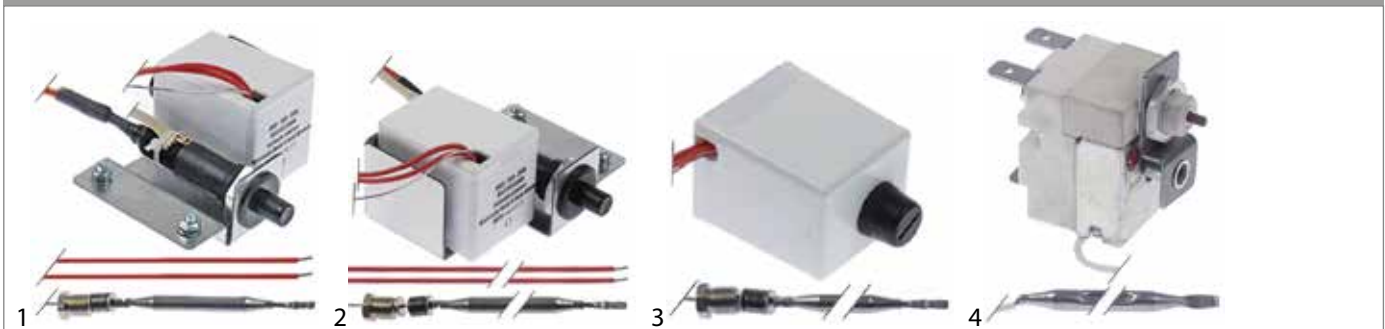







afb.	bestelnr.	T.uit (°C)	aantal polig (-polig)	SC (A)	voeler ø (mm)	voeler L (mm)	cap. (mm)	capillaire pijp geïsoleerd (mm)	stopbus	voeler	passend voor	fabrikantnr.
1	Op aanvraag <sup>1</sup>	-	1	-	6	78	700	-	M9x1	RVS	Falcon	537350031
2	Op aanvraag <sup>1</sup>	-	1	-	6	78	700	-	M9x1	RVS	Falcon	537350030
3	Op aanvraag <sup>1</sup>	-	1	-	6	78	700	-	M9x1	RVS	Falcon	536300036
4	9691.0280	124	1	16	6	71	2000	2000	-	RVS	Electrolux	0HA200

<sup>1</sup>met toebehoren





												
5	6	7	8									
afb.	bestelnr.	T.uit (°C)	aantal polig (-polig)	SC (A)	voeler ø (mm)	voeler L (mm)	cap. (mm)	capillaire pijp geïsoleerd (mm)	stopbus	voeler	passend voor	fabrikantnr.
5	9691.0285	135	1	16	6	75	600	-	-	koper	Baron Olis	0A046185 BN6A046185
6	9691.0362	140		16	6	112	410	20			Conti	415526
7	9691.0295	146	1	-	6	86	850	50	-	RVS	Jünger	422211
8	9239.1020	172	1	16	3	135	88	80	-	RVS	QualityEspresso	08324600

												
9	10	11										
afb.	bestelnr.	T.uit (°C)	aantal polig (-polig)	SC (A)	voeler ø (mm)	voeler L (mm)	cap. (mm)	capillaire pijp geïsoleerd (mm)	stopbus	voeler	passend voor	fabrikantnr.
9	9691.0305	230	1	16	4	100	900	410	-	-	Bartscher	016240438
9	9344.0255	230	2	16	5	48	440	150	-	-	Hualing	GDF1104-5
10	9691.0325	240	1	16	3,9	93	610	80	-	RVS	—	—
11	9691.0320	360	1	20	3	150	920	240	-	RVS	Cookmax RM-Gastro	402511200 402511200

regelthermostaten met temperatuur weergave

																	
1	2	3	4														
afb.	bestelnr.	t.max. (°C)	t.ber. (°C)	functie	SC (A)	voeler ø (mm)	cap. (mm)	inbouw ø (mm)	afb.	bestelnr.	t.max. (°C)	t.ber. (°C)	functie	SC (A)	voeler ø (mm)	cap. (mm)	inbouw ø (mm)
1	NML	40	-40 tot +40	1CO	10	8	1650	60	3	Op aanvraag	120	0-120	1CO	5	10	1500	80
2	9993.6480	120	0-120	1CO	5	8	1500	60	4	Op aanvraag	120	0-120	1CO	10	12	1200	60



afb.	bestelnr.	t.max. (°C)	t.ber. (°C)	functie	SC (A)	voeler ø (mm)	cap. (mm)	inbouw ø (mm)	afb.	bestelnr.	t.max. (°C)	t.ber. (°C)	functie	SC (A)	voeler ø (mm)	cap. (mm)	inbouw ø (mm)
5	9691.0365	320	0-320	1CO	10	8	1530		7	9998.2100	500	0-500	1CO	5	8	1100	60
6	9691.0370	450	50-450	1CO	5	6	1150	80									

## thermostaten opbouw

### RANCO

#### rechte externe voelers

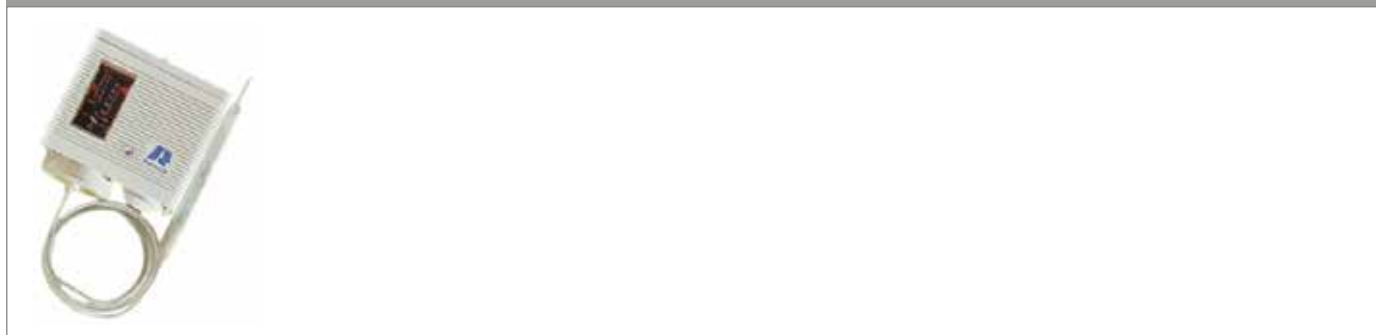

pos.	bestelnr.	t.ber. (°C)	differentie laag bereik (°C)	differentie hoog bereik (°C)	voeler ø (mm)	voeler L (mm)	cap. (mm)
1	9770.0008	-34 tot +32	8-22	4,0/25	9,5	150	1800
2	9770.0066	-5 tot +25	1,7-7	3-12	14,5	140	1800

#### spiraalvormige externe voelers

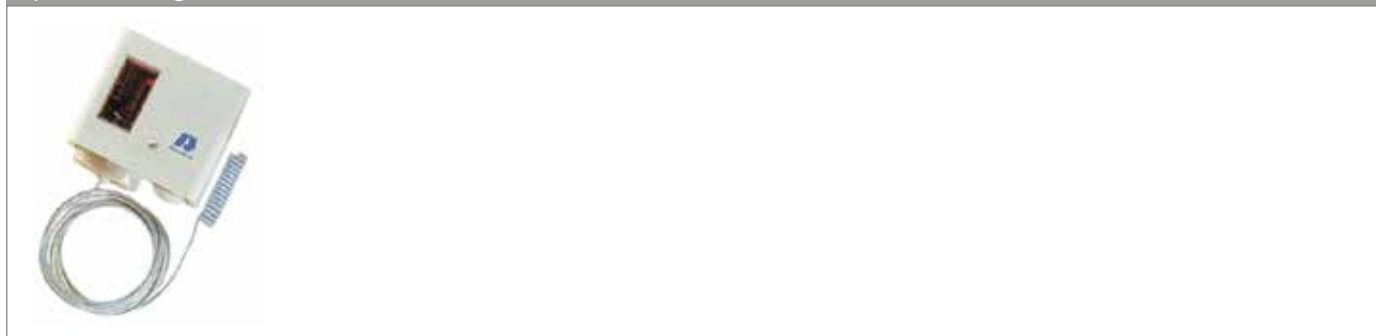

pos.	bestelnr.	t.ber. (°C)	differentie laag bereik (°C)	differentie hoog bereik (°C)	voeler ø (mm)	voeler L (mm)	cap. (mm)
1	9770.0012	-18 tot +13	1,7-7	3-12	9,5	38	2000
2	9770.0159	-5 tot +25	1,7-7	3-12	9,5	38	2000



SECOP DANFOSS

spiraalvormige externe voelers



pos.	bestelnr.	t.ber. (°C)	differentie laag bereik (°C)	differentie hoog bereik (°C)	voeler ø (mm)	voeler L (mm)	cap. (mm)
1	9180.2305	-30 tot +15	5,5-23	1,5-7	9,5	70	2000
2	9180.2306	-5 tot +35	4,5-25	1,8-7	9,5	70	2000

ruimte thermostaten

RANCO



pos.	bestelnr.	t.ber. (°C)	differentie laag bereik (°C)	differentie hoog bereik (°C)
2	9770.0008	-18 tot +13	vast ingesteld 1	vast ingesteld 1,5

staafthermostaten

maximaalthermostaten

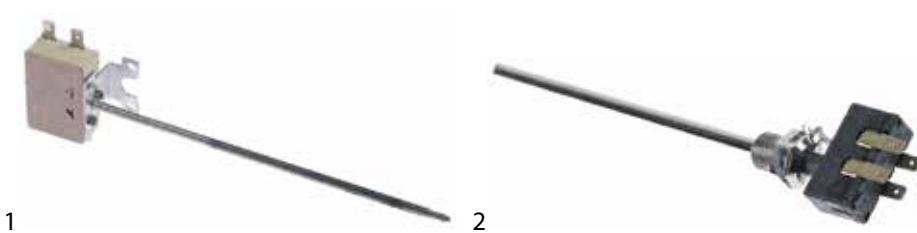

afb.	bestelnr.	t.ber. (°C)	aantal polig (-polig)	functie	SC (A)	voeler ø (mm)	voeler L (mm)	cap. (mm)	capillaire pijp geïsoleerd (mm)	stopbus	as ø (mm)
1	9089.0335	-	2	1NC/1NO	-	4	170	-	-	-	-
2	NML	0-145	2	2NC	20	8	187	-	-	-	-



staaththermostaten



afb.	bestelnr.	t.ber. (°C)	functie	aantal polig (-polig)	SC (A)	voeler ø (mm)	voeler L (mm)	V (V)
1	9691.0375	0-90	1CO	1	16	8	85	250
2	9691.0376	0-90	1CO	1	16	8	200	250
3	390368	38 tot 148°C/ -4 tot 107	1NO/1NC	1	15	15,7	91	125-250VAC

koelingthermostaten

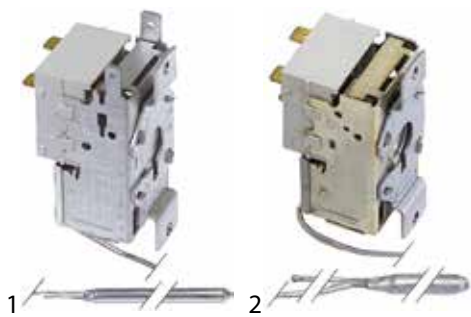

afb.	bestelnr.	t.ber. (°C)	voeler	cap. (mm)	type
1	9520.0034	-	ø10x110mm	1100	K55L5081
2	9520.0095	-	ø10x110mm	1500	K55L5082
2	9770.0057	-5 tot +13	ø10x100mm	2000	K22L2554

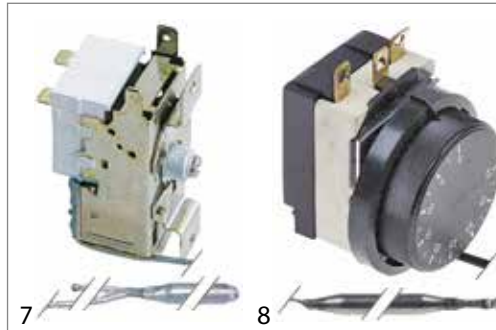

afb.	bestelnr.	t.ber. (°C)	voeler	cap. (mm)	type
7	9920.0100	+1,7 tot +9,5	ø10x110mm	1100	K55L1042
8	9691.0330	0 tot +40	ø6x110mm	1500	IMPORT
8	9987.0010	0 tot +40	ø6x110mm	1500	PRODIGY
8	9987.0013	-35 tot +35	ø6x110mm	1500	IMPORT
8	9987.0012	-35 tot +35	ø6x110mm	1800	PRODIGY

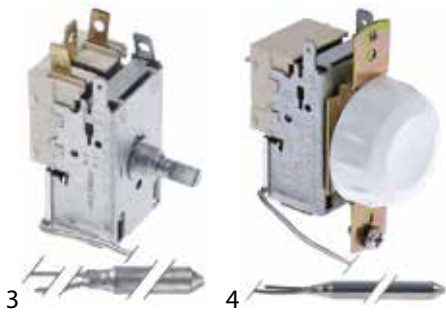

afb.	bestelnr.	t.ber. (°C)	voeler	cap. (mm)	type
3	9770.0100	-	ø9,5x130mm	2060	K22L8100
4	9920.0045	-	ø9,7x107mm	1110	K55L1047



pos.	bestelnr.	t.ber. (°C)	voeler ø (mm)	voeler L (mm)	cap. (mm)	type
1	9040.0040	-	8	120	-	-
2	9119.0015	-	9	42	1450	-
3	9770.0160	-	10	24	660	-
4	9770.0076	-	10	48	1500	K50H2005
5	NML	-14 tot -9	9	35	1600	K22L3021
6	9119.0010	-14,5 tot +20,5	9	40	2000	K22L1020
7	9770.0068	-2 tot +8	-	-	2000	K22L3521
8	9770.0059	-26,5 tot -19,5	9	40	1600	K22L3020
9	9160.0312	-6,4 tot +3,2	11	30	2100	K52L4512

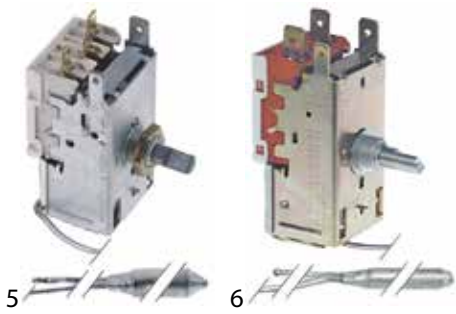

afb.	bestelnr.	t.ber. (°C)	voeler	cap. (mm)	type
5	9770.0081	-40 tot +40	ø9,5x107mm	1950	K57L2865
6	9770.0102	+1 tot +3	ø10x40mm	1870	K50L3194



pos.	bestelnr.	voeler ø (mm)	voeler L (mm)	cap. (mm)	type	passend voor	fabrikantnr.
1	9041.0002	-	-	750	K61L1500	Icematic Ranco Scotsman SF-Maschinen	CM29090002/0 K61-L1500 62026410 I-352
2	9042.1000	-	-	1200		ITV	273
3	9180.1920	-	-	1200	077B0028	Coreco Fagor Infrico	6021350023 6021350023 308X10
4	9180.1925	-	-	1200	077B0082L	—	—
5	9287.0233	-	-	1200	K50P1125	Ranco	K50-P1125
6	9770.0051	-	-	1200	K50P1127	Öztiryakiler Ranco	6268.00013.01 K50-P1127
7	9770.0128	-	-	1200	VA102 K50-H1105	Ranco	VA102
8	9770.0026	-	-	1200	VC101 K50-H1104	Ranco	VC101
9	9770.0053	-	-	1250	K50L3019	Brice Italia Eurfrigor Geofrigor Ranco	RF000610 RF000610 RF000610 K50-L3019
10	9770.0135	-	-	1250	K50P1118	Emmepi IME Turbo Mareno Ranco Telme	828317 TKS015 MA2523500 K50-P1118 F05.002.R
11	9180.1695	-	-	1300	077B7001	—	—
12	9180.1930	-	-	1300	077B7002	—	—
13	9180.0035	-	-	1500	077B7004	—	—
14	9042.1005	-	-	1500	K22 S1096	ITV	153
15	9770.0049	-	-	1500	K22L2025	Angelo-Po Ranco	32Z7450 K22-L2025
16	9770.0060	-	-	1500	K50L3207	Angelo-Po Eliwell Ranco Sagi	32Z6360 K50L3207 K50L3207000 K50-L3207 32Z6360
17	9770.0063	-	-	1500	K50L3383	Brema Brice Italia Cookmax Electrolux Eurfrigor Geofrigor Kastel	23005 926080 23005 085283 RF50B892 RF50B892 K00079
18	9770.0136	-	-	1500	K61L1505	Intimpex Ranco	0950 K61-L1505
19	9770.0006	-	-	1500	VI112 K59-H2805	Ranco	K59-H2805
20	9180.0034	-	-	1600	077B7003	—	—
21	9770.0138	-	-	1600	VP104 K60-L2024	Ranco	VP104
22	9770.0140	-	-	1800	K50-L3085	Mondial Ranco	1001086 K50-L3085
23	9401.0030	-	-	1800	K61L1501	GIGA Ranco Scotsman	I62026400 K61-L1501 620264.00
24	9180.0038	-	-	2000	077B7008	Electrolux Icematic Scotsman	OK8399 CM19797012/0 CM19797007

pos.	bestelnr.	voeler ø (mm)	voeler L (mm)	cap. (mm)	type	passend voor	fabrikantnr.
25	9770.0079	-	-	2000	K22L1082	Brema Brice Italia Cookmax Electrolux Eurfrigor Geofrigor Kastel NTF Rancilio Ranco	R23591 926081 23591 087969 RF50B893 RF50B893 K03089 N23591 68023591 K22-L1082
26	9770.0050	-	-	2000	K22L2030	Angelo-Po GIGA Mach Migel Ranco Scotsman Simag	32Z3890 I62026414 80001LT092 1LT020 K22-L2030 62026414 Z1EL011
27	9041.0004	-	-	2000	K50L3006	Angelo-Po GIGA Ranco Scotsman	3034730 I620209100 K50-L3006 620209.00
28	9160.0122	-	-	2000	K50L3078	Dexion Electrolux MBM-Italia Ranco	013475-00 0A8089 013475-00 K50-L3078
29	9770.0066	-	-	2000	K50L3209	Intimpex Ranco	1068 K50-L3209
30	9770.0062	-	-	2000	K50P1115/007	Eliwell Ranco	K50P1115012 K50-P1115
31	9160.0124	-	-	2000	K50P1117	Dexion Electrolux IME Turbo MBM-Italia Ranco	013477-00R 0A8135 TK5014 013477-00R K50-P1117
32	9770.0142	-	-	2000	K50P6073/001	Cookmax Liebherr Ranco	6151995 6151995 K50-P6073
33	9770.0144	-	-	2000	K55L5026	Electrolux Eliwell Eliwell Ranco Zanussi	082025 K55L5026 K55L5026000 K55-L5026 082025
34	9770.0058	-	-	2000	K55L5047	Friulinox Ranco	FR995385 K55-L5047
35	9160.0455	-	-	2000	K55L5078	Electrolux Ranco	083125 K55-L5078
36	9160.0364	-	-	2000	K55L5080	Electrolux Ranco Zanussi	083147 K55-L5080 083147
37	9770.0148	-	-	2000	K57-L2866	Cookmax Liebherr Ranco	6151753 6151753 K57-L2866
38	9770.0002	-	-	2000	VB107 K50-H1107	Ranco	VB107
39	9770.0004	-	-	2000	VC110 K50-H1108	Ranco	K50-H1108
40	9770.0045	-	-	2000	VI109 K59-H1303	Ranco	VI109
41	9770.0034	-	-	2000	VS105 K54-H1404	Ranco	VS105
42	9770.0146	-	-	2100	K50L3163	Brema Electrolux Eliwell Eliwell NTF Ranco	23034 085314 K50L3163 K50L3163000 NR23034 K50-L3163
43	9770.0065	-	-	2150	K61L1502	Luxia Ranco	L4750 K61-L1502
44	9180.0030	-	-	2300	077B7006	—	—
45	9770.0150	-	-	2300	K61L1506	Brema Ranco	23004 K61-L1506
46	9770.0067	-	-	2500	K22L1034	Intimpex Ranco	1006 K22-L1034
47	9770.0048	-	-	2500	K22L2021	Ranco Simag	K22-L2021 Z1EL012

Tabel wordt vervolgd op de volgende pagina



pos.	bestelnr.	voeler ø (mm)	voeler L (mm)	cap. (mm)	type	passend voor	fabrikantnr.
48	9770.0152	-	-	2500	K50P1135	Angelo-Po Ranco Scotsman	32V4270 K50-P1135 62020900
49	9770.0054	-	-	2550	K22L2557	Eliwell Eliwell Friulinox Mareno Ranco	K22L2557 K22L2557000 995352 MA2475912 K22-L2557
50	9770.0106	1,9	-	1200	K50-L3231/002	Cornelius Sencotel S.L. SPM Staff Ice System	04.BA0031.001 SL37AAL3231 04.BA0031.001 SL37AAL3231
51	9770.0130	2	-	1000	K54-L1870	—	—
52	9770.0108	2	-	1200	K50-L3421	Ranco Tefcold	K50-L3421 1022600019
53	9770.0110	2	-	1230	K50-L3218	Eliwell Eliwell Icematic Ranco SF-Maschinen Ugolini	K50L3218 K50L3218000 CM19797019/0 K50-L3218 I-1058 21087-00000
54	9770.0112	2	-	1500	K50-L3337	IARP Ranco	0225090 K50-L3337
55	9770.0072	2	-	1800	K61L1504	Electrolux Icematic Ranco Scotsman Zanussi	086288 CM19797031/0 K61-L1504 620264-11 086288
56	9770.0114	2	-	1800	K61L1508	Icematic Ranco Scotsman Simag WEGA	CMCF62026416 K61-L1508 62026402 62026416 WY31F62026416
57	9180.2310	2	-	2000	-	La-Sommeliere	7038257
58	9770.0116	2	-	2000	K22L2082	Migel Ranco	1LT112 K22 L2082
59	9119.0020	2	-	2000	K50L3324	Eliwell Eliwell Foster Icematic Ranco Scotsman SF-Maschinen	K50L3324 K50L3324000 15315803 CM19797026/0 K50-L3324 63000500 I-35
60	9770.0118	2	-	2000	K59L1045	Migel	1LT019
61	9161.0305	2	-	2000	WPF206B-L	Manitowoc	20-0883-3
62	9770.0120	2	-	2250	K22L1081	Kastel Ranco	K00080 K22-L1081
63	9119.0145	2	-	2250	K61L1509	Ranco Scotsman Simag	K61-L1509 62026415 62026415
64	9770.0074	2	-	2300	K22L1083	Brema Electrolux NTF Ranco	R23597 087804 23597 K22-L1083
65	9770.0080	2	-	2500	K50-L3210	IARP Ranco	3301323 K50-L3210
66	9770.0122	2	-	3000	K50L3274	Brema Electrolux NTF Ranco	23421 089078 NR23421 K50-L3274

pos.	bestelnr.	voeler ø (mm)	voeler L (mm)	cap. (mm)	type	passend voor	fabrikantnr.
67	9691.0377	2	20	700	-	Philips Whirlpool	481927128578 481927128578
68	9770.0069	2	-	1200	K50L3081	Ranco	K50-L3081
69	9691.0379	2,5	5	1110	-	Amitek	R00081
70	9691.0378	4,6	6	2000	K50S3493	ITV Ranco	274 k50-S3493
71	9520.0165	7	108	1400	K22-L1529	Icematic Ranco SF-Maschinen	CM19797025/0 K22-L1529 I-238



afb.	bestelnr.	t.ber. (°C)	voeler	cap. (mm)	fabrikant
1	9691.0380	0 tot +40	ø6x110mm	1500	IMPORT
1	9987.0016	0 tot +40	ø6x110mm	1500	PRODIGY
1	9691.0381	-35 tot +35	ø6x110mm	1500	IMPORT
1	9987.0014	-35 tot +35	ø6x110mm	1500	PRODIGY
2	9691.0382	30-120	ø6x110mm	1300	PRODIGY
2	9691.0383	-35 tot +35	ø6x110mm	-	IMPORT
2	9987.0018	-35 tot +35	ø6x110mm	-	PRODIGY



afb.	bestelnr.	t.ber. (°C)	voeler ø (mm)	voeler L (mm)	cap. (mm)	type	passend voor	fabrikantnr.
1	9691.0384	-	2	10	1500	-	Brice Italia	926136



diversen



afb.	bestelnr.	omschrijving
1	NML	thermostaat Miniclic 102°C ombouwset

afb.	bestelnr.	omschrijving
2		Op aanvraag thermostaat vast op 232°C kabellengte 190mm

toebehoren

asverlengingen



afb.	bestelnr.	omschrijving	totale lengte (mm)	VPE (stuk)
1	9995.1025	asverlenging L1 13mm totale lengte 35mm vpe 1stuk	35	1
2	9995.1026	asverlenging L1 23mm totale lengte 45mm as ø 6mm	45	1
3	9700.0281	asverlenging L1 18mm totale lengte 28mm vpe 1stuk	28	1
3	9995.1027	asverlenging L1 28mm totale lengte 38mm vpe 1stuk	38	1

pos.	bestelnr.	voor pijp ø (mm)	voor voeler ø (mm)	VPE (stuk)
1	9993.7448		6	1
2	9992.5129		9	1
3	9992.5128		9	1
4	9995.1024	2x8,5	-	1

bevestigingsdelen



afb.	bestelnr.	omschrijving
1	9162.9930	houder voor contactthermostaat
2	9993.7142	houder voor contactthermostaat
3	9993.7023	houder voor contactthermostaat
4	9998.1865	verbindingsstuk voor thermostaat en schakelaar

afb.	bestelnr.	voor pijp ø (mm)	voor voeler ø (mm)	L (mm)	VPE (stuk)
1	9998.3290	8,5	6	25	1
1	9191.0130	8,5	6	25	10
2	9995.1023	17x6	6		1

voor maximaalthermostaten

pos.	bestelnr.	voor pijp ø (mm)	voor voeler ø (mm)	VPE (stuk)
1	9998.1815	8,5	6	1

voelerklemmen

klembeugels

voor thermostaten



pos.	bestelnr.	voor pijp ø (mm)	voor voeler ø (mm)	VPE (stuk)
1	9998.1850	-	6	1
2	9993.7144	-	6	10
3	9998.1845	-	8	1
4	9993.7146	-	8	10

afb.	bestelnr.	voor pijp ø (mm)	voor voeler ø (mm)	afb.	bestelnr.	voor pijp ø (mm)	voor voeler ø (mm)
1	9998.1875	-	3,1	2	9998.1870	9	6



## klemveren

## voor thermostaten



pos.	bestelnr.	voor pijp ø (mm)	voor voeler ø (mm)	VPE (stuk)
1	9998.1831	7	6	
2	vervangen	8	6	
3	9023.0050	8,5	4	1
4	9993.7150	8,5	4	5
5	9008.1831	8,5	6	1
6	9993.7152	8,5	6	5

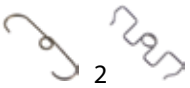

afb.	bestelnr.	voor pijp ø (mm)	voor voeler ø (mm)	L (mm)	VPE (stuk)
1	9998.1832	2x8,5	4	42	1
2	9995.1022	2x8,5	6	36	1

## voor maximaalthermostaten



afb.	bestelnr.	voor pijp ø (mm)	voor voeler ø (mm)	VPE (stuk)
1	9995.1016	8,5	4	1
1	9993.7154	8,5	4	5
2	9108.2275	8,5	3,1	1
2	9993.7156	8,5	3,1	5
3	9998.1855	8,5	4	1
3	9995.1017	8,5	4	5
4	9995.1017	8,5	6	1
5	9995.1018	17x6	6	1
5	9993.7158	17x6	6	5
6	9998.0815	2x8,5	6	1
6	9993.7160	2x8,5	6	5



afb.	bestelnr.	voor pijp ø (mm)	voor voeler ø (mm)	VPE (stuk)
7	9995.1021	8,5	4	1

## capilaire pijp klemmen



afb.	bestelnr.	omschrijving	voor pijp ø (mm)	VPE (stuk)
1	9995.1019	capilairklem voor pijp ø 6mm vpe 1stuk	6	1
1	9993.7162	capilairklem voor pijp ø 6mm vpe 5stuk	6	5
2	9162.1730	capilairklem voor pijp ø 8,5mm	8,5	
3	NML	capilairklem voor pijp ø 8,5mm	8,5	
4	9995.1020	capilairklem voor pijp ø 8,5mm vpe 1stuk	8,5	1
4	9993.7164	capilairklem voor pijp ø 8,5mm vpe 10stuk	8,5	10
5	9992.5127	capilairklem voor pijp ø 17x6mm	17x6	

## capilairebescherm pijp

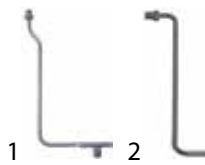

afb.	bestelnr.	G	H1 (mm)	H2 (mm)	L1 (mm)	L2 (mm)
1	9993.7166	M10x1	200	12	190	95
2	9191.0036	M10x1	210	-	25	30

## stopbustoebehoren

## doorvoeren



afb.	bestelnr.	OD	BD	voeler ø max. (mm)	SW
1	9030.0201	3/8"	M13x1	9,5	17
1	9030.0200	M12x0,75	M9x1	6,5	19
1	9401.0066	M14x1,5	M10x0,75	6,5	22
2	9993.7168	M12x0,75	M9x1		
3	9998.1835	M12x0,75	M9x1		
3	9998.1515	M14x1	M9x1		
3	9998.1510	M14x1	M10x1		
4	9998.1840	M14x1	M9x1		



afb.	bestelnr.	OD	BD	voeler ø max. (mm)	SW
5	9993.7170	M14x1	M9x1	7	22

## gleufschijven



afb.	bestelnr.	omschrijving
1	9690.0805	gleufschijf AD ø 7,8mm sleufbreedte 1,3mm VPE 10
1	9690.0840	gleufschijf AD ø 8,8mm sleufbreedte 1,2mm VPE 10



## rubbers



afb.	bestelnr.	omschrijving	materiaal	ø (mm)	VPE (stuk)
1	9995.0685	pakking grafiet ø 7,5mm L 7mm vpe 1stuk	grafiet	7,5	1
2	9995.0686	pakking silicone ø 7,8mm L 5mm blauw Shore 55°	silicone	7,8	10
3	9690.0830	pakking ø 8x8,7mm VPE 10m inkepingen silicone	silicone	8x8,7	

## gleufschroeven



afb.	bestelnr.	omschrijving
1	9998.0080	sleufschroef draad M10x1 vpe 10stuk
1	9998.1820	sleufschroef draad M9x1 vpe 10stuk

## klemmschroeven



afb.	bestelnr.	omschrijving
1	9998.5157	knelschroef draad M10x1 voeler ø max. 4,5mm
2	9162.3272	knelschroef draad M12x1 voeler ø max. 4mm RVS
3	9993.7174	schroefconnectie voor voeler draad M12x1

## blindschroefverbindingen



afb.	bestelnr.	omschrijving
1	9986.1852	blindschroefkoppeling draad M10x1 SB 10 H 12mm

## voelerbuizen



afb.	bestelnr.	G	L (mm)	materiaal	ø (mm)
1	9995.1003	1/4"	120	RVS	9
2	9450.0712	1/2"	44	RVS	10
3	9995.1007	1/2"	107	RVS	6,5

afb.	bestelnr.	G	L (mm)	materiaal	ø (mm)
4	ABJ099001	1/2"	107	RVS	8
5	9995.1008	1/2"	120	RVS	6,5

afb.	bestelnr.	G	L (mm)	materiaal	ø (mm)
6	NML	1/2"	210	RVS/messing	6,5
7	9130.0146	1/2"	90/150	RVS/messing	8

afb.	bestelnr.	G	L (mm)	materiaal	ø (mm)
8	9475.0250	3/4"	310	RVS	8
9	9995.1010	M10x1	108	RVS	10

afb.	bestelnr.	G	L (mm)	materiaal	ø (mm)
10	9993.7476	M10x1	230	RVS	4
11	9995.1011	M12x0,75	66	RVS	10
12	9995.1012	M12x1,75	95	RVS/messing	10

afb.	bestelnr.	G	L (mm)	materiaal	ø (mm)
13	NML	M14x1	34	RVS	9
14	9995.1014	M14x1	36	RVS	11
15	9995.1015	M14x1	40	RVS	9
16	Op aanvraag	M14x1	147	RVS	7



## verbindingsbeugel



afb.	bestelnr.	omschrijving	VPE (stuk)
1	9993.7174	bevestigingsbeugel voor thermostaat en schakelaar	
2	9690.0790	verbindingsbeugel kort voor schakelaar vpe 1stuk	1
2	9690.0368	verbindingsbeugel kort voor schakelaar vpe 10stuk	10
3	AAJ679100	verbindingsbeugel lang voor thermostaat vpe 1stuk	1
3	9993.7176	verbindingsbeugel lang voor thermostaat vpe 10stuk	10